

RKEF Series

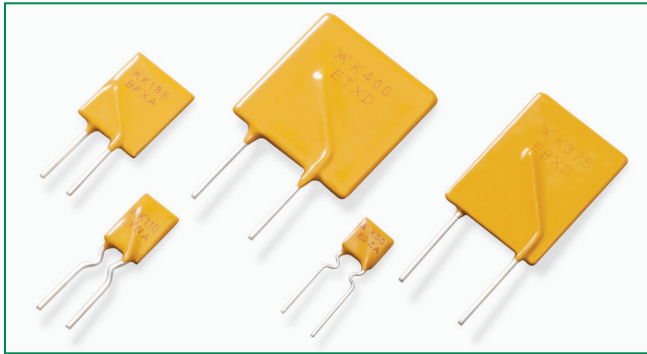

**Description**

Littelfuse PolySwitch radial-leaded devices represent the most comprehensive and complete set of PPTC products available in the industry today. RKEF series is for balance of voltage rating (60V) and hold current (up to 5A).

**Features**

- Resettable and single-use overcurrent devices
- Wide range of form factor and termination methods
- Devices compatible with high-volume electronics assembly
- RoHS compliant, Lead-Free and Halogen-Free

**Applications**

- Satellite video receivers
- Industrial controls
- Transformers
- Computer motherboards
- Modems
- USB hubs, ports and peripherals
- IEEE 1394 ports
- CD-ROMs
- Game machines
- Battery packs
- Phones
- Fax machines
- Analog and digital line cards
- Printers

**Agency Approvals**

AGENCY	AGENCY FILE NUMBER
	E74889
	78165
	72161791

**Additional Information**



Datasheet



Resources



Samples

**Electrical Characteristics**

Part Number	$I_H$	$I_T$	$V_{MAX}$		$I_{MAX}$		$P_{D\ TYP}$	Max Time-to-trip		$R_{MIN}$	$R_{MAX}$	$R_{1MAX}$	Lead Size (mm <sup>2</sup> /AWG)
	(A)	(A)	(V <sub>DC</sub> )	(V <sub>AC RMS</sub> )	(DC <sub>ADC</sub> )	(AC <sub>ARMS</sub> )	(W)	(A)	(s)	(Ω)	(Ω)	(Ω)	
<b>RKEF – 60V</b>													
RKEF050	0.50	1.00	60	—	40	—	1.00	8.00	0.8	0.320	0.529	0.900	0.205/24
RKEF065	0.65	1.30	60	—	40	—	1.25	8.00	1.0	0.250	0.450	0.720	0.205/24
RKEF075	0.75	1.50	60	—	40	—	1.40	8.00	1.5	0.200	0.390	0.640	0.205/24
RKEF090	0.90	1.80	60	—	40	—	1.50	8.00	2.0	0.190	0.320	0.520	0.205/24
RKEF110	1.10	2.20	60	—	40	—	2.20	8.00	3.0	0.170	0.280	0.470	0.520/20
RKEF135	1.35	2.70	60	—	40	—	2.30	8.00	4.5	0.110	0.220	0.370	0.520/20
RKEF160	1.60	3.20	60	—	40	—	2.40	8.20	9.0	0.100	0.200	0.320	0.520/20
RKEF185	1.85	3.70	60	—	40	—	2.60	9.25	12.6	0.060	0.152	0.250	0.520/20
RKEF250	2.50	5.00	60	—	40	—	2.80	12.50	15.6	0.040	0.085	0.140	0.520/20
RKEF300	3.00	6.00	60	—	40	—	3.20	15.00	19.8	0.030	0.050	0.080	0.520/20
RKEF375	3.75	7.50	60	—	40	—	3.40	18.75	22.0	0.017	0.040	0.060	0.520/20
RKEF400	4.00	8.00	60	—	40	—	3.70	20.00	24.0	0.014	0.038	0.060	0.520/20
RKEF500	5.00	10.00	60	—	40	—	5.00	25.00	28.0	0.012	0.030	0.050	0.520/20

**Notes:**

- $I_H$  : Hold current: maximum current device will pass without interruption in 20°C still air.
- $I_T$  : Trip current: minimum current that will switch the device from low resistance to high resistance in 20°C still air.
- $V_{MAX}$  : Maximum continuous voltage device can withstand without damage at rated current.
- $I_{MAX}$  : Maximum fault current device can withstand without damage at rated voltage.
- $P_D$  : Power dissipated from device when in the tripped state in 20°C still air.

- $R_{MIN}$  : Minimum resistance of device as supplied at 20°C unless otherwise specified.
- $R_{MAX}$  : Maximum resistance of device as supplied at 20°C unless otherwise specified.
- $R_{1MAX}$  : Maximum resistance of device when measured one hour post reflow (surface-mount device) or one hour post trip (radial-leaded device) at 20°C unless otherwise specified.

\* Electrical characteristics determined at 25°C.

### Temperature Rerating

Maximum Ambient Temperature										
	-40°C	-20°C	0°C	20°C	25°C	40°C	50°C	60°C	70°C	85°C
Hold Current (A)										
RKEF – 60V										
RKEF050	0.73	0.65	0.58	0.50	0.48	0.42	0.38	0.34	0.31	0.26
RKEF065	0.94	0.85	0.75	0.65	0.63	0.54	0.50	0.44	0.40	0.34
RKEF075	1.09	0.98	0.86	0.75	0.73	0.62	0.58	0.51	0.46	0.39
RKEF090	1.30	1.17	1.04	0.90	0.87	0.75	0.69	0.61	0.55	0.47
RKEF110	1.60	1.43	1.27	1.10	1.06	0.92	0.85	0.75	0.67	0.57
RKEF135	1.96	1.76	1.55	1.35	1.31	1.12	1.04	0.92	0.83	0.71
RKEF160	2.32	2.08	1.84	1.60	1.55	1.33	1.23	1.08	0.98	0.83
RKEF185	2.68	2.41	2.13	1.85	1.79	1.54	1.43	1.26	1.13	0.96
RKEF250	3.63	3.25	2.88	2.50	2.43	2.08	1.93	1.70	1.52	1.31
RKEF300	4.35	3.90	3.45	3.00	2.91	2.50	2.30	2.04	1.84	1.55
RKEF375	5.44	4.88	4.31	3.75	3.64	3.11	2.90	2.54	2.29	1.94
RKEF400	5.80	5.20	4.60	4.00	3.88	3.32	3.08	2.73	2.45	2.08
RKEF500	7.25	6.50	5.75	5.00	4.85	4.15	3.85	3.41	3.06	2.59

### Temperature Rerating Curve

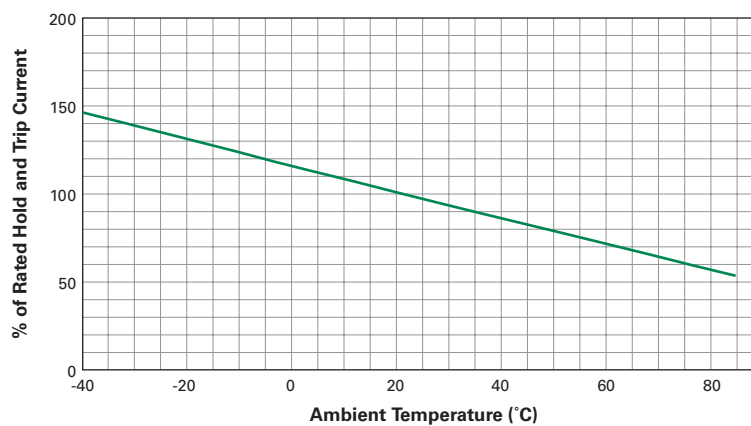

**Typical Time-to-Trip Curves at 20°C**

**RKEF**

- A = RKEF050      H = RKEF185
- B = RKEF065      I = RKEF250
- C = RKEF075      J = RKEF300
- D = RKEF090      K = RKEF375
- E = RKEF110      L = RKEF400
- F = RKEF135      M = RKEF500
- G = RKEF160

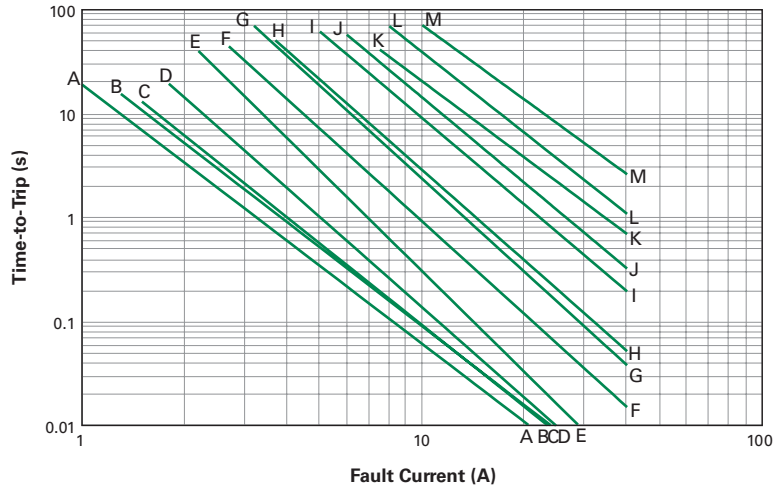

**Physical Specifications**

<b>Lead Material</b>	RKEF050 to 090 : Tin-plated Copper, 0.205mm <sup>2</sup> (24AWG), ø0.51mm (0.020in) RKEF110 to 500 : Tin-plated Copper, 0.52mm <sup>2</sup> (20AWG), ø0.81mm (0.032in)
<b>Soldering Characteristics</b>	Solderability per ANSI/J-STD-002 Category 3
<b>Solder Heat Withstand</b>	RKEF050-RKEF185: per IEC-STD 68-2-20, Test Tb, Method 1a, Condition a; Can Withstand 5s at 260°C ±5°C All Other Sizes: per IEC-STD 68-2-20, Test Tb, Method 1a, Condition b; RKEF Can Withstand 10s at 260°C ±5°C
<b>Insulating Material</b>	Cured, Flame-retardant Epoxy Polymer; Meets UL 94V-0
<b>Operation Temperature</b>	-40°C~85°C

**Note:** Devices are not designed to be placed through a reflow process.

**Environmental Specifications**

Test	Conditions	Resistance Change
<b>Passive Aging</b>	-40°C, 1000 hrs	±5%
	85°C, 1000 hrs	±5%
<b>Humidity Aging</b>	85°C, 85% R.H., 1000 hrs	±10%
<b>Thermal Shock</b>	85°C, -40°C (10 Times)	±10%
<b>Solvent Resistance</b>	MIL-STD-202, Method 215F	No change

<b>Moisture Resistance Level</b>	Level 1, J-STD-020
<b>Storage Conditions</b>	40°C max, 70% RH max; devices should remain in original sealed bags prior to use. Devices may not meet specified values if these storage conditions are exceeded.

### Dimension Figures

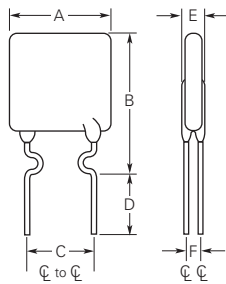

**Figure 1**

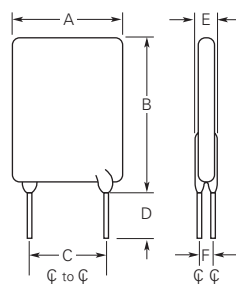

**Figure 2**

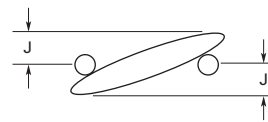

**Figure 3**

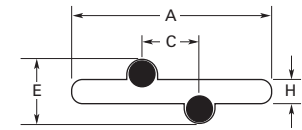

**Figure 4**

### Dimensions and Weights

Part Number	Dimensions in Millimeters (Inches)										Figure	Device Mass (g) (Only for Reference)
	A		B		C		D		E			
	Min	Max	Min	Max	Min	Max	Min	Max	Min	Max		
<b>RKEF – 60V</b>												
RKEF050	—	7.10 (0.28)	—	11.43 (0.45)	4.32 (0.17)	5.84 (0.23)	7.60 (0.30)	—	—	3.56 (0.14)	1,3,4	0.166
RKEF065	—	7.11 (0.28)	—	12.20 (0.48)	4.32 (0.17)	5.84 (0.23)	7.60 (0.30)	—	—	3.56 (0.14)	1,3,4	0.182
RKEF075	—	7.87 (0.31)	—	12.20 (0.48)	4.32 (0.17)	5.84 (0.23)	7.60 (0.30)	—	—	3.56 (0.14)	1,3,4	0.201
RKEF090	—	7.87 (0.31)	—	13.97 (0.55)	4.32 (0.17)	5.84 (0.23)	7.60 (0.30)	—	—	3.56 (0.14)	1,3,4	0.235
RKEF110	—	7.60 (0.30)	—	15.00 (0.59)	4.32 (0.17)	5.84 (0.23)	7.60 (0.30)	—	—	4.10 (0.16)	1,3,4	0.353
RKEF135	—	10.20 (0.40)	—	17.00 (0.67)	4.32 (0.17)	5.84 (0.23)	7.60 (0.30)	—	—	3.81 (0.15)	2,3,4	0.438
RKEF160	—	12.20 (0.48)	—	18.30 (0.72)	4.32 (0.17)	5.84 (0.23)	7.60 (0.30)	—	—	3.81 (0.15)	2,3,4	0.546
RKEF185	—	13.00 (0.51)	—	18.80 (0.74)	4.32 (0.17)	5.84 (0.23)	7.60 (0.30)	—	—	3.81 (0.15)	2,3,4	0.538
RKEF250	—	14.00 (0.55)	—	20.60 (0.81)	4.32 (0.17)	5.84 (0.23)	7.60 (0.30)	—	—	3.00 (0.12)	2,3,4	0.775
RKEF300	—	16.50 (0.65)	—	21.20 (0.83)	4.32 (0.17)	5.84 (0.23)	7.60 (0.30)	—	—	3.00 (0.12)	2,3,4	0.971
RKEF375	—	16.50 (0.65)	—	25.20 (0.99)	9.40 (0.37)	10.90 (0.43)	7.60 (0.30)	—	—	3.00 (0.12)	2,3,4	1.142
RKEF400	—	21.00 (0.83)	—	24.90 (0.98)	9.40 (0.37)	10.90 (0.43)	7.60 (0.30)	—	—	3.00 (0.12)	2,3,4	1.391
RKEF500	—	24.10 (0.95)	—	29.00 (1.14)	9.40 (0.37)	10.90 (0.43)	7.60 (0.30)	—	—	3.00 (0.12)	2,3,4	1.783

**Packaging and Marking Information**

Part Number	Bag Quantity	Tape and Reel Quantity	Ammo Pack Quantity	Standard Package Quantity	Part Marking	Agency Recognition
<b>RKEF – 60V</b>						
RKEF050	500	—	—	10,000	K50	UL, CSA, TÜV
RKEF065	500	—	—	10,000	K65	UL, CSA, TÜV
RKEF075	500	—	—	10,000	K75	UL, CSA, TÜV
RKEF090	500	—	—	10,000	K90	UL, CSA, TÜV
RKEF110	500	—	—	10,000	K110	UL, CSA, TÜV
RKEF135	500	—	—	10,000	K135	UL, CSA, TÜV
RKEF160	500	—	—	10,000	K160	UL, CSA, TÜV
RKEF185	500	—	—	10,000	K185	UL, CSA, TÜV
RKEF250	500	—	—	10,000	K250	UL, CSA, TÜV
RKEF300	250	—	—	5,000	K300	UL, CSA, TÜV
RKEF375	250	—	—	5,000	K375	UL, CSA, TÜV
RKEF400	250	—	—	5,000	K400	UL, CSA, TÜV
RKEF500	250	—	—	5,000	K500	UL, CSA, TÜV

**Part Ordering Number System**

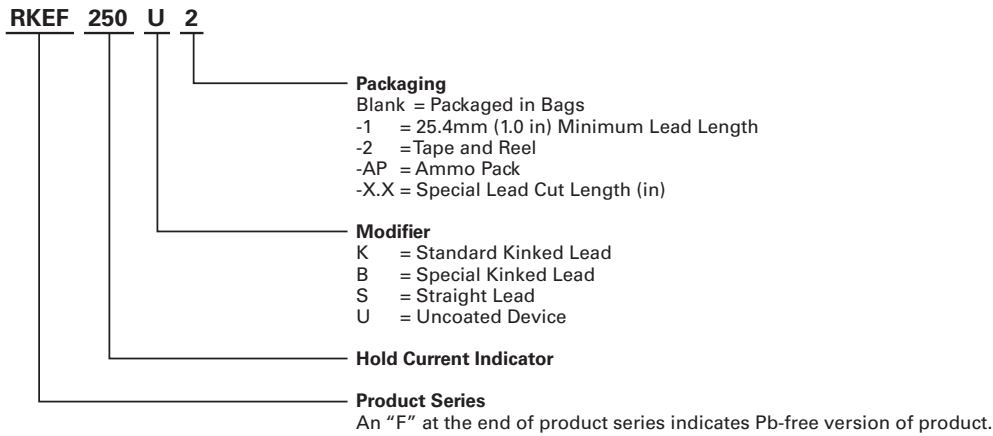

**Note:** Kinked parts are recommended to control the height of the part on the PCB in non-auto PCB applications.

### Tape and Reel Specifications

RKEF devices are available in tape and reel packaging per EIA468-B/IEC60286-2 standards. See Figures 1 and 2 for details.

Description	EIA Mark	Dimension (mm)	Tolerance
Carrier Tape Width	W	18	-0.5/+1.0
Hold-Down Tape Width	W <sub>4</sub>	11	Minimum
Top Distance between Tape Edges	W <sub>6</sub>	3	Maximum
Sprocket Hole Position	W <sub>5</sub>	9	-0.5/+0.75
Sprocket Hole Diameter	D <sub>0</sub>	4	± 0.2
Abscissa to Plane (Straight Lead) (RKEF135 To RKEF500)	H	18.5	± 2.5
Abscissa to Plane (Kinked Lead) (RKEF050 To RKEF110)	H <sub>0</sub>	16.0	± 0.5
Abscissa to Top (RKEF050 To RKEF185)	H <sub>1</sub>	32.2	Maximum
Abscissa to Top* (RKEF250 To RKEF500)	H <sub>1</sub>	47.5	Maximum
Overall Width with Lead Protrusion (RKEF050 To RKEF185)	C <sub>1</sub>	43.2	Maximum
Overall Width with Lead Protrusion* (RKEF250 To RKEF500)	C <sub>1</sub>	58	Maximum
Overall Width without Lead Protrusion (RKEF050 To RKEF185)	C <sub>2</sub>	42.5	Maximum
Overall Width without Lead Protrusion* (RKEF250 To RKEF500)	C <sub>2</sub>	57.0	Maximum
Lead Protrusion	L <sub>1</sub>	1.0	Maximum
Protrusion of Cut-Out	L	11.0	Maximum
Protrusion beyond Hold-down Tape	I <sub>2</sub>	Not Specified	—
Sprocket Hole Pitch	P <sub>0</sub>	12.7	± 0.3
Device Pitch (RKEF050 To RKEF185)	—	12.7	± 0.3
Device Pitch (RKEF250 To RKEF500)	—	25.4	± 0.61
Pitch Tolerance	—	20 Consecutive	± 1
Tape Thickness	T	0.9	Maximum
Overall Tape and Lead Thickness (RKEF050 To RKEF185)	T <sub>1</sub>	1.5	Maximum
Overall Tape and Lead Thickness (RKEF250 To RKEF500)	T <sub>1</sub>	2.3	Maximum
Splice Sprocket Hole Alignment	—	0	± 0.3
Body Lateral Deviation	Δh	0	± 1.0
Body Tape Plane Deviation	Δp	0	± 1.3
Ordinate to Adjacent Component Lead (RKEF050 To RKEF300)	P <sub>1</sub>	3.81	± 0.7
Ordinate to Adjacent Component Lead (RKEF375 To RKEF500)	P <sub>1</sub>	7.62	± 0.7
Lead Spacing* (RKEF050 To RKEF300)	F	5.05	± 0.75
Lead Spacing* (RKEF375 To RKEF500)	F	10.15	± 0.75
Reel Width (RKEF050 To RKEF185)	W <sub>2</sub>	56.0	Maximum
Reel Width* (RKEF250 To RKEF500)	W <sub>2</sub>	63.5	Maximum
Reel Diameter	A	370.0	Maximum
Space between Flanges* (RKEF050 To RKEF185)	W <sub>1</sub>	48.0	Maximum
Space between Flanges* (RKEF250 To RKEF500)	W <sub>1</sub>	55.0	Maximum
Arbor Hold Diameter	C	26.0	± 12.0
Core Diameter*	N	91.0	Maximum
Box	—	64/372/362	Maximum
Consecutive Missing Places	—	None	—
Empty Places per Reel	—	0.1%	Maximum

\*Differs from EIA specification.

**Tape and Reel Diagrams**

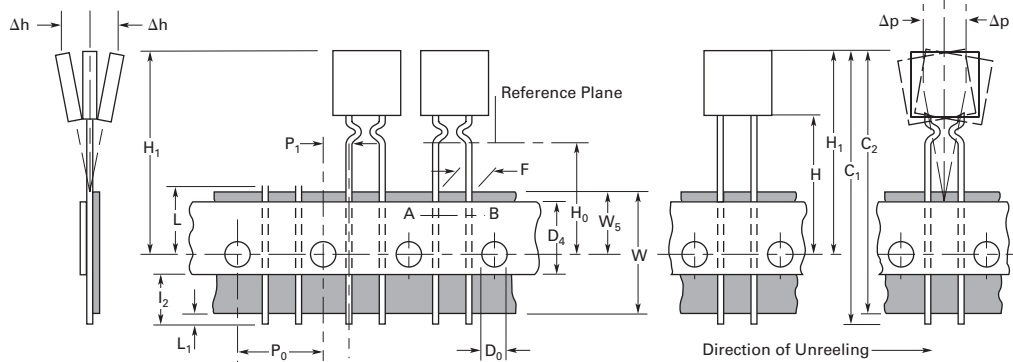

**Figure 1**

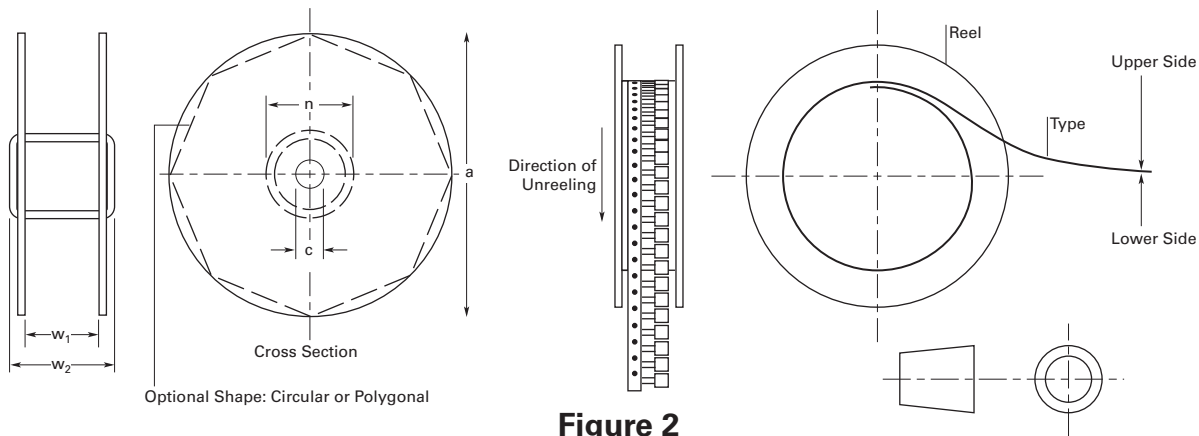

**Figure 2**

**WARNING**

- Users should independently evaluate the suitability of and test each product selected for their own application.
- Operation beyond the maximum ratings or improper use may result in device damage and possible electrical arcing and flame.
- These devices are intended for protection against damage caused by occasional overcurrent or overtemperature fault conditions and should not be used when repeated fault conditions or prolonged trip events are anticipated.
- Contamination of the PPTC material with certain silicone-based oils or some aggressive solvents can adversely impact the performance of the devices.
- Device performance can be impacted negatively if devices are handled in a manner inconsistent with recommended electronic, thermal, and mechanical procedures for electronic components.
- PPTC devices are not recommended for installation in applications where the device is constrained such that its PTC properties are inhibited, for example in rigid potting materials or in rigid housings, which lack adequate clearance to accommodate device expansion.
- Operation in circuits with a large inductance can generate a circuit voltage ( $Ldi/dt$ ) above the rated voltage of the device.

**Disclaimer Notice** - Information furnished is believed to be accurate and reliable. However, users should independently evaluate the suitability of and test each product selected for their own applications. Littelfuse products are not designed for, and may not be used in, all applications. Read complete Disclaimer Notice at [www.littelfuse.com/disclaimer-electronics](http://www.littelfuse.com/disclaimer-electronics).