

# Ceramic Bandpass Filter

50Ω 1893 to 1920 MHz

## Features

- Small size (0.126"x0.063"x0.051")
- Temperature stable
- Hermetically sealed
- LTCC construction

## Applications

- Harmonic Rejection
- Transmitters / receivers
- PCS

# BFCN-1900+

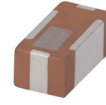

Generic photo used for illustration purposes only

CASE STYLE: FV1206-5

### +RoHS Compliant

The +Suffix identifies RoHS Compliance. See our web site for RoHS Compliance methodologies and qualifications

Available Tape and Reel at no extra cost

Reel Size	Devices/Reel
7"	20, 50, 100, 200, 500, 1000, 3000

## Specification Definition

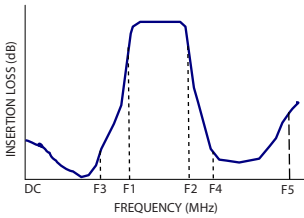

## Functional Schematic

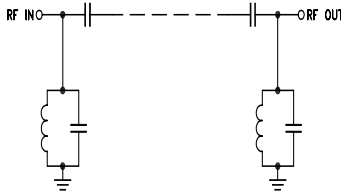

## Top View

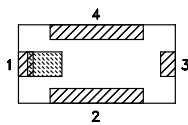

## Pad Connections

Input	1
Output	3
Ground	2,4

## Electrical Specifications<sup>1,2</sup> at 25°C

Parameter	F#	Frequency (MHz)	Min.	Typ.	Max.	Unit	
Pass Band	Center Frequency	—	—	1900	—	MHz	
	Insertion Loss	F1 - F2	1893 - 1920	—	2.6	3.2	dB
	VSWR	F1 - F2	1893 - 1920	—	1.4	—	:1
Stop Band, Lower	Insertion Loss	DC - F3	—	—	35	—	dB
	VSWR	DC - F3	—	—	30	—	:1
Stop Band, Upper	Insertion Loss	F4 - F5	2153 - 5500	—	25	—	dB
	VSWR	F4 - F5	2153 - 5500	—	50	—	:1

1. Measured on Mini-Circuits Characterization Test Board TB-518+.

2. This filter is not intended for use as a DC Blocking circuit element. In Application where DC voltage is present at either input or output ports, blocking capacitors are required at the corresponding RF port.

## Maximum Ratings

Operating Temperature	-40°C to +85°C
Storage Temperature*	-55°C to +100°C
RF Power Input**	2W at 25°C

\* 12 months

\*\*Passband rating, derate linearly to 0.5W at 85°C ambient

Permanent damage may occur if any of these limits are exceeded.

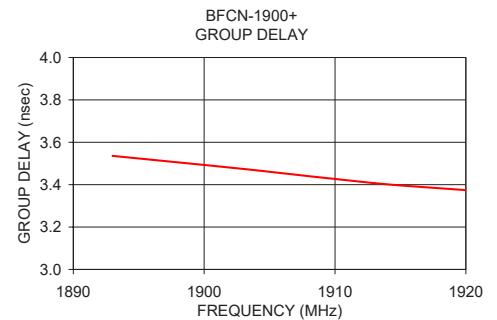
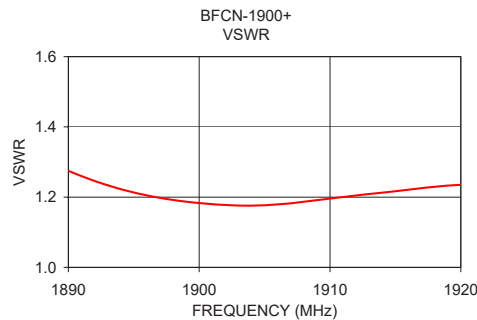
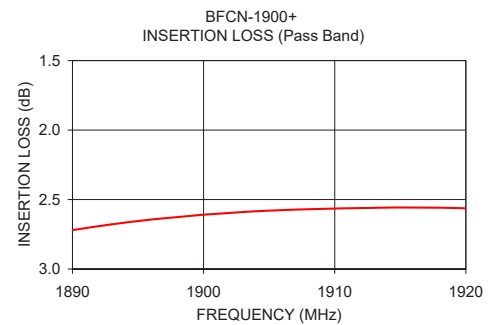
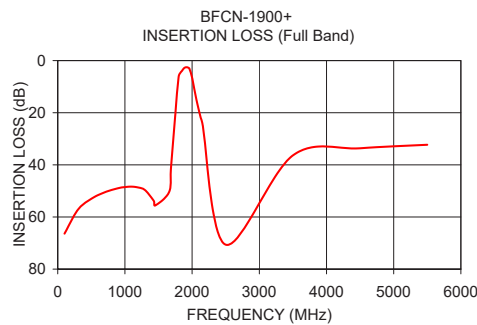

### Full Band Performance

Frequency (MHz)	Insertion Loss (dB)	VSWR (:1)
100.00	66.39	138.63
500.00	53.03	102.96
1000.00	48.53	94.67
1200.00	48.68	92.97
1660.00	50.31	45.30
1687.00	40.78	37.21
1800.00	6.13	2.56
1893.00	2.68	1.23
1920.00	2.56	1.23
2000.00	6.53	4.20
2153.00	24.20	43.19
3500.00	36.36	137.82
4500.00	33.62	95.34
5500.00	32.30	90.59

### Pass Band Performance

Frequency (MHz)	Insertion Loss (dB)	Group Delay (nsec)
1893.00	2.68	3.54
1903.00	2.59	3.47
1913.00	2.56	3.41
1920.00	2.56	3.37

### Pad Connections

Input	1
Output	3
Ground	2,4

### PCB Land Pattern

### Outline Drawing

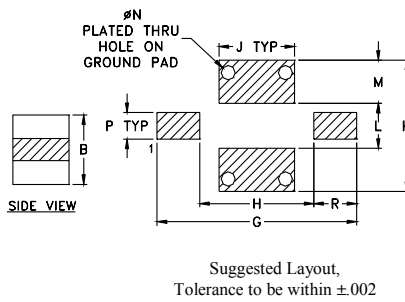
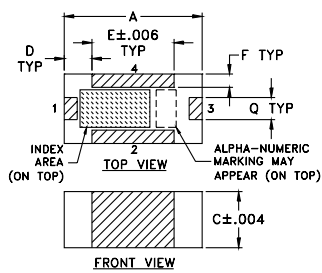

### Demo Board MCL P/N: TB-518+ Suggested PCB Layout (PL-305)

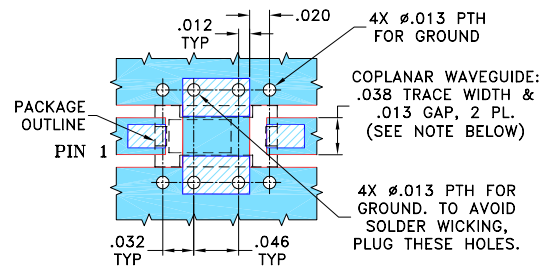

NOTE: 1. TRACE WIDTH IS SHOWN FOR ROGERS R04350B WITH DIELECTRIC THICKNESS .020" ± .0015". COPPER: 1/2 OZ. EACH SIDE. FOR OTHER MATERIALS TRACE WIDTH MAY NEED TO BE MODIFIED.  
2. BOTTOM SIDE OF THE PCB IS CONTINUOUS GROUND PLANE.

- DENOTES PCB COPPER LAYOUT WITH SMOBC (SOLDER MASK OVER BARE COPPER)
- DENOTES COPPER LAND PATTERN FREE OF SOLDER MASK

### Outline Dimensions (inch/mm)

A	B	C	D	E	F	G	H	J
.126	.063	.051	.026	.075	.012	.182	.104	.069
3.20	1.60	1.30	0.66	1.91	0.30	4.62	2.64	1.75
K	L	M	N	P	Q	R		wt
.119	.041	.039	.013	.024	.020	.039		grams
3.02	1.04	0.99	0.33	0.61	0.51	0.99		.020

### Additional Notes

- A. Performance and quality attributes and conditions not expressly stated in this specification document are intended to be excluded and do not form a part of this specification document.
- B. Electrical specifications and performance data contained in this specification document are based on Mini-Circuit's applicable established test performance criteria and measurement instructions.
- C. The parts covered by this specification document are subject to Mini-Circuits standard limited warranty and terms and conditions (collectively, "Standard Terms"); Purchasers of this part are entitled to the rights and benefits contained therein. For a full statement of the Standard Terms and the exclusive rights and remedies thereunder, please visit Mini-Circuits' website at [www.minicircuits.com/MCLStore/terms.jsp](http://www.minicircuits.com/MCLStore/terms.jsp)