

NCP630

Linear Voltage Regulators - Fast

3.0 A

The NCP630 is a low dropout positive voltage regulator that is capable of providing a guaranteed output current of 3.0 A with a maximum dropout voltage of 1.25 V at 3.0 A over temperature. The fast turn on time allows step changes in loads commonly found in low voltage microprocessor applications. The NCP630 is currently offered as an adjustable output version that can be programmed down to 1.2 V with two external resistors and as a fixed output version at 3.47 V. On chip trimming adjusts the reference/output voltage to within $\pm 1.5\%$ accuracy. Internal protection features consist of output current limiting and thermal shutdown. NCP630 is available in D²PAK package.

Features

- Output Current of 3.0 A
- 1.25 V Maximum Dropout Voltage at 3.0 A Over Temperature
- Voltage on Shutdown Pin is TTL Compatible
- Reference/Output Voltage Trimmed to $\pm 1.5\%$
- Current Limit Protection
- Thermal Shutdown Protection
- -40°C to 125°C Junction Temperature Range
- Pb-Free Packages are Available

Applications

- Microprocessor Power Supplies
- DSP Power Supplies
- SMPS Post Regulation
- Battery Chargers

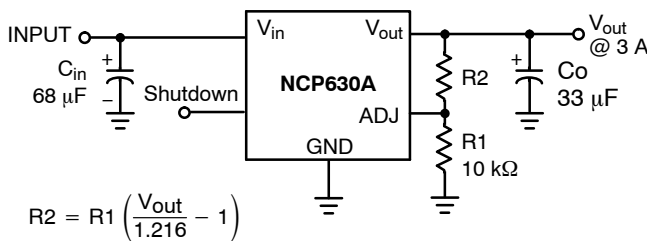

Figure 1. Typical Application Circuit for NCP630A

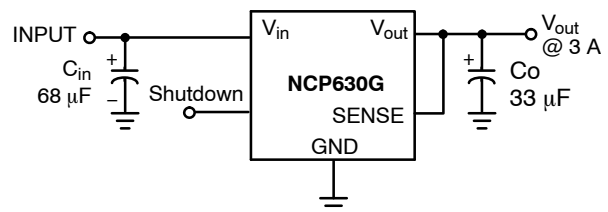

Figure 2. Typical Application Circuit for NCP630G



ON Semiconductor®

<http://onsemi.com>

MARKING DIAGRAM

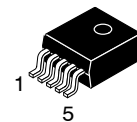

D²PAK
D2T SUFFIX
CASE 936A



NCP630A

Tab = Ground
Pin 1. Shutdown
2. V_{in}
3. Ground
4. V_{out}
5. Adj

NCP630G

Tab = Ground
Pin 1. Shutdown
2. V_{in}
3. Ground
4. V_{out}
5. Sense

x = Specific Device Code
A = Assembly Location
WL = Wafer Lot
Y = Year
WW = Work Week
G = Pb-Free Package

ORDERING INFORMATION

See detailed ordering and shipping information in the package dimensions section on page 9 of this data sheet.

NCP630

MAXIMUM RATINGS

Rating	Symbol	Value	Unit
Input Voltage (Note 1)	V_{in}	12	V
Shutdown Voltage	Shutdown	-0.3 to $V_{in} + 0.3$	V
Output Voltage	V_{out}	-0.3 to $V_{in} + 0.3$	V
Output Short Circuit Duration (Note 2)	-	Infinite	-
Power Dissipation and Thermal Characteristics Case 936F (D ² PAK) Power Dissipation (Note 2) Thermal Resistance, Junction-to-Ambient Thermal Resistance, Junction-to-Case	P_D $R_{\theta JA}$ $R_{\theta JC}$	Internally Limited 45 5.0	W °C/W °C/W
Operating Junction Temperature Range	T_J	-40 to 125	°C
Storage Temperature Range	T_{stg}	-55 to 150	°C
Lead Soldering Temperature @ 260°C	T_{solder}	10	sec

Maximum ratings are those values beyond which device damage can occur. Maximum ratings applied to the device are individual stress limit values (not normal operating conditions) and are not valid simultaneously. If these limits are exceeded, device functional operation is not implied, damage may occur and reliability may be affected.

- This device series contains ESD protection and exceeds the following tests:
Human Body Model JESD 22-A114-B
Machine Model JESD 22-A115-A

- The maximum package power dissipation is:

$$P_D = \frac{T_{J(max)} - T_A}{R_{\theta JA}}$$

PIN FUNCTION DESCRIPTION

Pin No.	NCP630A	NCP630G	Description
1	Shutdown	Shutdown	This input is used to place the NCP630 into shutdown mode. The NCP630 is active when a voltage greater than 2.0 V is applied. The NCP630 will be placed into a shutdown mode when a voltage less than 0.8 V is applied. If left unused then connect the pin high.
2	V_{in}	V_{in}	Positive power supply input voltage
3, Tab	Ground	Ground	Power supply ground
4	V_{out}	V_{out}	Regulated output voltage
5	Adj	-	This pin is to be Connected to the R_{sense} resistors on the output. It maintains 1.216 V between itself and ground. Refer to Figure 1 for equation.
5	-	Sense	This pin is to be connected near the load for better regulation.

NCP630

ELECTRICAL CHARACTERISTICS ($C_{in} = 68 \mu\text{F}$, $C_{out} = 33 \mu\text{F}$, $V_{in} = V_{out} + 1.5 \text{ V}$, $I_{out} = 10 \text{ mA}$, for typical value $T_J = 25^\circ\text{C}$, for min and max values $T_J = -40^\circ\text{C}$ to 125°C unless otherwise noted.)

Characteristic	Symbol	Min	Typ	Max	Unit
NCP630A					
Reference Voltage ($V_{in} = V_{out} + 1.5 \text{ V}$ to 7.0 V , $I_{out} = 10 \text{ mA}$ to 3.0 A , $T_J = 25^\circ\text{C}$) ($V_{in} = V_{out} + 1.5 \text{ V}$ to 7.0 V , $I_{out} = 10 \text{ mA}$ to 3.0 A , $T_J = -40^\circ\text{C}$ to 125°C)	V_{adj}	1.198 1.180	1.216 –	1.234 1.253	V
Line Regulation (Notes 3 and 4) ($V_{in} = V_{out} + 1.5 \text{ V}$ to 7.0 V , $T_J = 25^\circ\text{C}$) ($V_{in} = V_{out} + 1.5 \text{ V}$ to 7.0 V , $T_J = -40^\circ\text{C}$ to 125°C)	Reg_{line}	– –	0.02 0.06	– –	%
Load Regulation (Notes 3 and 4) ($I_{out} = 10 \text{ mA}$ to 3.0 A , $T_J = 25^\circ\text{C}$) ($I_{out} = 10 \text{ mA}$ to 3.0 A , $T_J = -40^\circ\text{C}$ to 125°C)	Reg_{load}	– –	0.01 0.06	– –	%
Dropout Voltage (Measured at $V_{out} - 2\%$) ($I_{out} = 300 \text{ mA}$) ($I_{out} = 3.0 \text{ A}$)	$V_{in} - V_{out}$	– –	0.75 1.0	1.0 1.25	V
Ground Pin Current in Normal Mode ($I_{out} = 300 \text{ mA}$) ($I_{out} = 3.0 \text{ A}$)	I_{Gnd}	– –	0.4 1.0	1.0 2.0	mA
Ground Pin Current in Shutdown Mode ($V_{shutdown} = 0.8 \text{ V}$)	I_{Gnd}	–	15	50	μA
Peak Output Limit	I_{out}	3.0	6.0	–	A
Short Current Limit (Note 5)	I_{SC}	–	6.5	–	A
Thermal Shutdown	–	–	165	–	$^\circ\text{C}$
Shutdown Input Threshold Voltage (Voltage Increasing, Output Turns On, Logic High) (Voltage Decreasing, Output Turns Off, Logic Low)	$V_{th(shutdown)}$	2.0 –	– –	– 0.8	V
Turn-off Delay, $I_{out} = 3.0 \text{ A}$	$T_{D(off)}$	–	20	–	μs
Turn-on Delay, $I_{out} = 3.0 \text{ A}$	$T_{D(on)}$	–	25	–	μs
Shutdown Input Low Current ($V_{Shutdown} = 0.8 \text{ V}$), (Negative current flows out of pin)	I_{iL}	–10	–5.0	–1.0	μA
Shutdown Input High Current ($V_{Shutdown} = 2.0 \text{ V}$), (Negative current flows out of pin)	I_{iH}	–10	–4.5	–1.0	μA
Ripple Rejection ($C_{out} = 100 \mu\text{F}$, $f = 1.0 \text{ kHz}$)	RR	–	85	–	dB
Output Noise Density ($f = 120 \text{ Hz}$)	–	–	0.6	–	$\mu\text{V}/\sqrt{\text{Hz}}$
Output Noise Voltage ($f = 20 \text{ Hz} - 100 \text{ kHz}$)	V_n	–	210	–	μV_{rms}

- Low duty cycle pulse techniques are used during testing to maintain the junction temperature as close to ambient as possible.
- Line regulation is defined as the change in output voltage for a change in input voltage. Load regulation is defined as the change in output voltage for a change in output load current at a constant temperature. The limits for line and load regulation are contained within the reference voltage specification, V_{adj} . Typical numbers are included in the specification for line and load regulation.
- The short circuit limit is for device protection. Maximum output current is guaranteed to be greater or equal to 3.0 A with a 6.0 A typical as listed in the peak output limit specification.

NCP630

ELECTRICAL CHARACTERISTICS ($C_{in} = 68 \mu\text{F}$, $C_{out} = 33 \mu\text{F}$, $V_{in} = V_{out} + 1.5 \text{ V}$, $I_{out} = 10 \text{ mA}$, for typical value $T_J = 25^\circ\text{C}$, for min and max values $T_J = 0^\circ\text{C}$ to 125°C unless otherwise noted.)

Characteristic	Symbol	Min	Typ	Max	Unit
NCP630G					
Output Voltage ($V_{in} = 5.0 \text{ V}$ to 7.0 V , $I_{out} = 10 \text{ mA}$ to 3.0 A , $T_J = 25^\circ\text{C}$) ($V_{in} = 5.0 \text{ V}$ to 7.0 V , $I_{out} = 10 \text{ mA}$ to 3.0 A , $T_J = 0^\circ\text{C}$ to 125°C)	V_{out}	3.418 3.383	3.470 –	3.522 3.557	V
Line Regulation (Notes 6 and 7) ($V_{in} = 5.0 \text{ V}$ to 7.0 V , $T_J = 25^\circ\text{C}$) ($V_{in} = 5.0 \text{ V}$ to 7.0 V , $T_J = 0^\circ\text{C}$ to 125°C)	Reg_{line}	– –	0.02 0.06	– –	%
Load Regulation (Notes 6 and 7) ($I_{out} = 10 \text{ mA}$ to 3.0 A , $T_J = 25^\circ\text{C}$) ($I_{out} = 10 \text{ mA}$ to 3.0 A , $T_J = 0^\circ\text{C}$ to 125°C)	Reg_{load}	– –	0.01 0.06	– –	%
Dropout Voltage (Measured at $V_{out} - 2\%$) ($I_{out} = 300 \text{ mA}$) ($I_{out} = 3.0 \text{ A}$)	$V_{in} - V_{out}$	– –	0.75 1.0	1.0 1.25	V
Ground Pin Current in Normal Mode ($I_{out} = 300 \text{ mA}$) ($I_{out} = 3.0 \text{ A}$)	I_{Gnd}	– –	0.4 1.0	1.0 2.0	mA
Ground Pin Current in Shutdown Mode ($V_{shutdown} = 0.8 \text{ V}$)	I_{Gnd}	–	26	50	μA
Peak Output Limit	I_{out}	3.0	5.0	–	A
Short Current Limit (Note 8)	I_{SC}	–	5.0	–	A
Thermal Shutdown	–	–	165	–	$^\circ\text{C}$
Shutdown Input Threshold Voltage (Voltage Increasing, Output Turns On, Logic High) (Voltage Decreasing, Output Turns Off, Logic Low)	$V_{th(shutdown)}$	2.0 –	– –	– 0.8	V
Turn-off Delay, $I_{out} = 3.0 \text{ A}$	$T_{D(off)}$	–	20	–	μs
Turn-on Delay, $I_{out} = 3.0 \text{ A}$	$T_{D(on)}$	–	25	–	μs
Shutdown Input Low Current ($V_{in} = 0.8 \text{ V}$), (Negative current flows out of pin)	I_{iL}	–10	–5.0	–1.0	μA
Shutdown Input High Current ($V_{in} = 2.0 \text{ V}$), (Negative current flows out of pin)	I_{iH}	–10	–4.5	–1.0	μA
Ripple Rejection ($C_{out} = 100 \mu\text{F}$, $f = 1.0 \text{ kHz}$)	RR	–	85	–	dB
Output Noise Density ($f = 120 \text{ Hz}$)	–	–	0.6	–	$\mu\text{V}/\sqrt{\text{Hz}}$
Output Noise Voltage ($f = 10 \text{ Hz} - 100 \text{ kHz}$)	V_n	–	210	–	μV_{rms}

6. Low duty cycle pulse techniques are used during testing to maintain the junction temperature as close to ambient as possible.
7. Line regulation is defined as the change in output voltage for a change in input voltage. Load regulation is defined as the change in output voltage for a change in output load current at a constant temperature. The limits for line and load regulation are contained within the output voltage specification, V_{out} . Typical numbers are included in the specification for line and load regulation.
8. The short circuit limit is for device protection. Maximum output current is guaranteed to be greater or equal to 3.0 A with a 5.0 A typical as listed in the peak output limit specification.

NCP630

TYPICAL CHARACTERISTICS

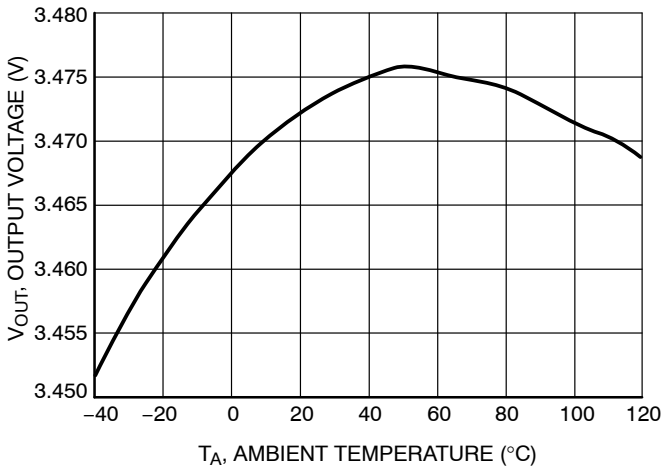

Figure 3. Output Voltage versus Temperature

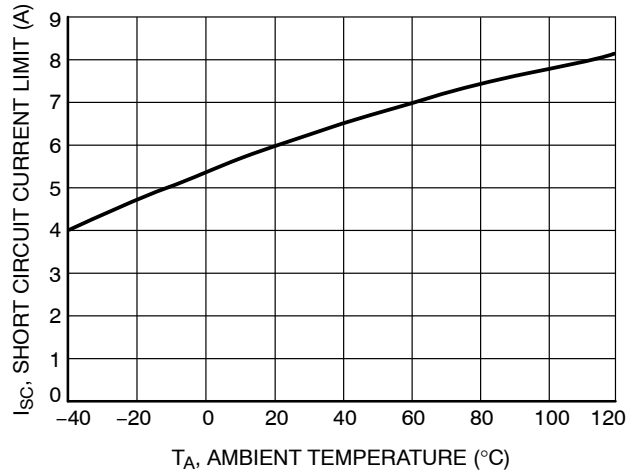

Figure 4. Short Circuit Current Limit versus Temperature

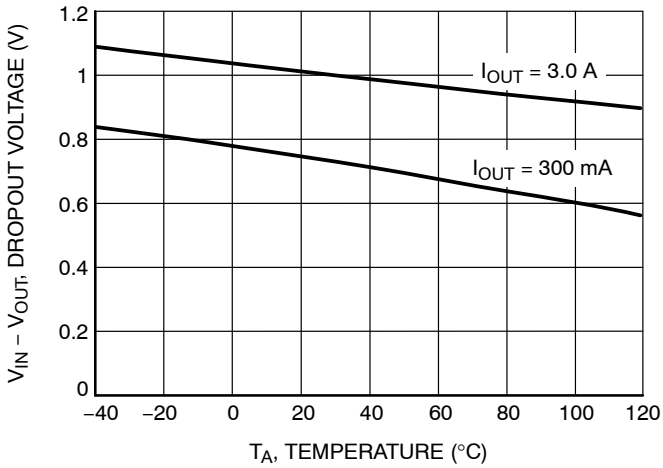

Figure 5. Dropout Voltage versus Temperature

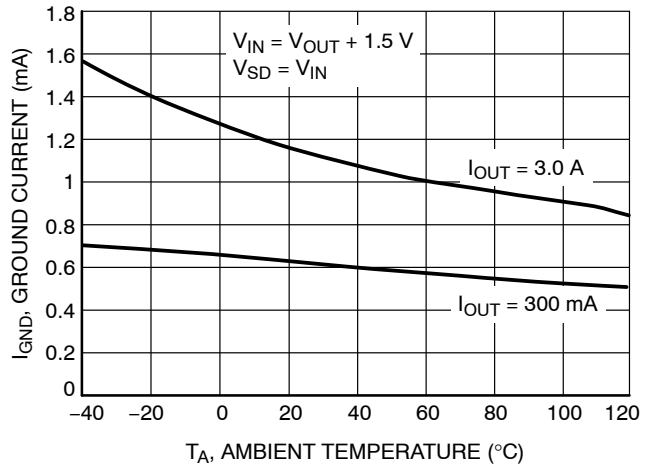

Figure 6. Ground Current versus Temperature

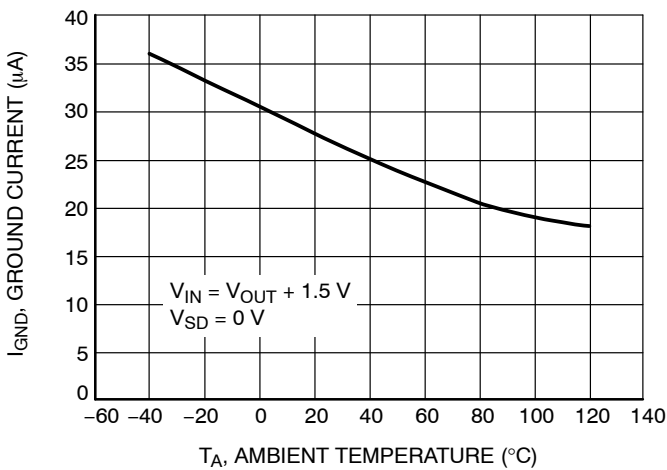

Figure 7. Ground Pin Current in Shutdown Mode versus Temperature

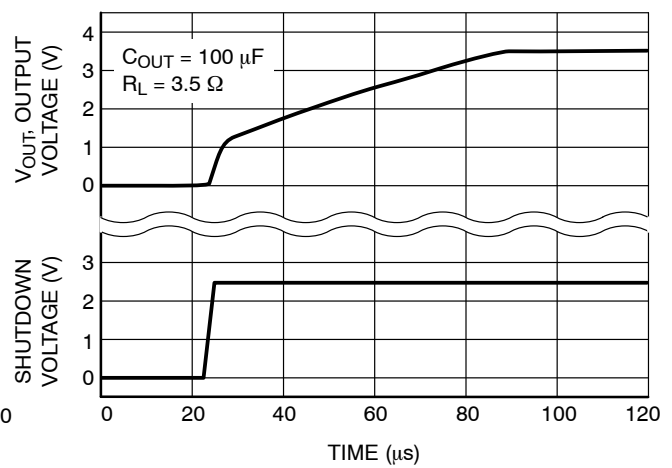

Figure 8. Start-up Transient

NCP630

TYPICAL CHARACTERISTICS

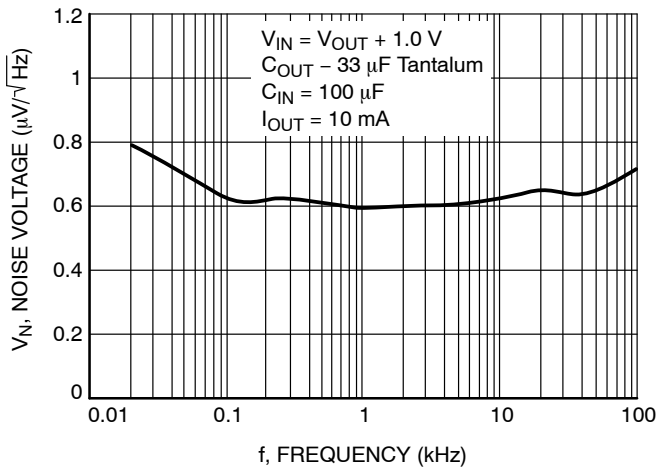

Figure 9. Output Noise Density

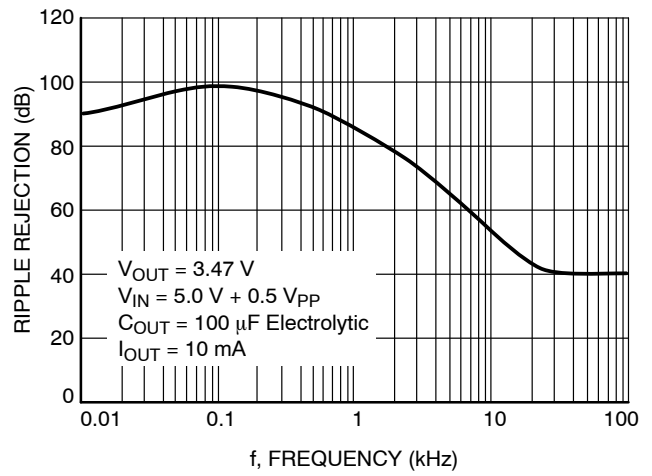

Figure 10. Ripple Rejection

APPLICATION INFORMATION

Input Capacitor

The minimum capacitance required for stability is a 68 μF aluminum electrolytic or tantalum capacitor. The maximum ESR allowed for stability is 5.0 Ω . The capacitor should be placed as close as possible to the input of the device.

The placement of a ceramic capacitor in parallel is not recommend due to possible instabilities.

Output Capacitor

A minimum output capacitor value of 33 μF is required for stability. The type of capacitor can be aluminum electrolytic or tantalum capacitor. ESR can vary up to a maximum of 2.0 ohms for stability. The capacitor should be placed as close as possible to the output of the device.

The placement of a ceramic capacitor in parallel is not recommend due to possible instabilities.

Sense Pin

The sense pin of the NCP630G will need to be connected near the output voltage. This provides great advantages when the linear regulator can't be near the load. The sense pin will monitor the load and allow the linear regulator to adjust for losses in the line between itself and the load. Thus it will provide good accuracy for a remote load.

ADJ Pin

The typical application circuits for the fixed and adjustable output regulators are shown in Figures 1 and 2. The adjustable devices develop and maintain the nominal 1.216 V reference voltage between the adjust and ground pins. The adjust pin current, I_{adj} , is typically 40 nA and normally lower than the current flowing through R1 and R2, thus it generates a small output voltage error that can usually be ignored. For the fixed output devices R1 and R2 are included within the device.

Reverse Current

Some situations might occur were the output pin is raised to a voltage while the input pin is at zero volts. This situation will not damage the device.

If the output voltage is raised to a higher voltage than the input voltage a diode is recommended from output to input with the anode connect to the output pin.

Thermal Considerations

This series contains an internal thermal limiting circuit that is designed to protect the regulator in the event that the maximum junction temperature is exceeded. When activated, typically at 165°C, the regulator output switches off and then back on as the die cools. As a result, if the device is continuously operated in an overheated condition, the output will appear to be oscillating. This feature provides protection from a catastrophic device failure due to accidental overheating. It is not intended to be used as a substitute for proper heatsinking. The maximum device power dissipation can be calculated by:

$$P_D = \frac{T_{J(\text{max})} - T_A}{R_{\theta JA}}$$

The devices are available in surface mount D²PAK package. The package has an exposed metal tab that is specifically designed to reduce the junction to air thermal resistance, $R_{\theta JA}$, by utilizing the printed circuit board copper as a heat dissipater. Figure 11 shows typical $R_{\theta JA}$ values that can be obtained from a square pattern using economical single sided 2.0 ounce copper board material. The final product thermal limits should be tested and quantified in order to insure acceptable performance and reliability. The actual $R_{\theta JA}$ can vary considerably from the graphs shown. This will be due to any changes made in the copper aspect ratio of the final layout, adjacent heat sources, and air flow.

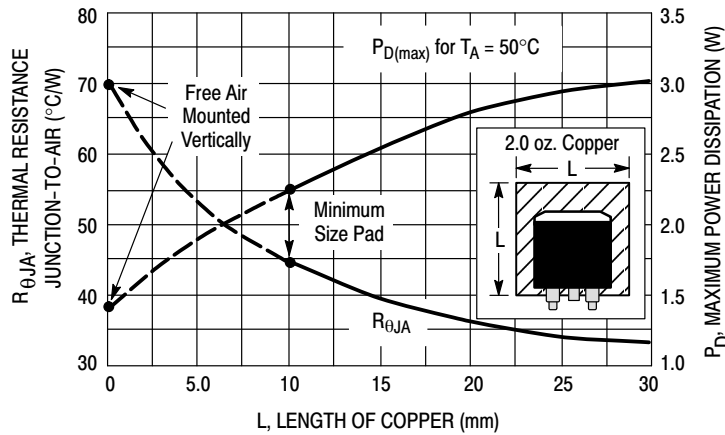
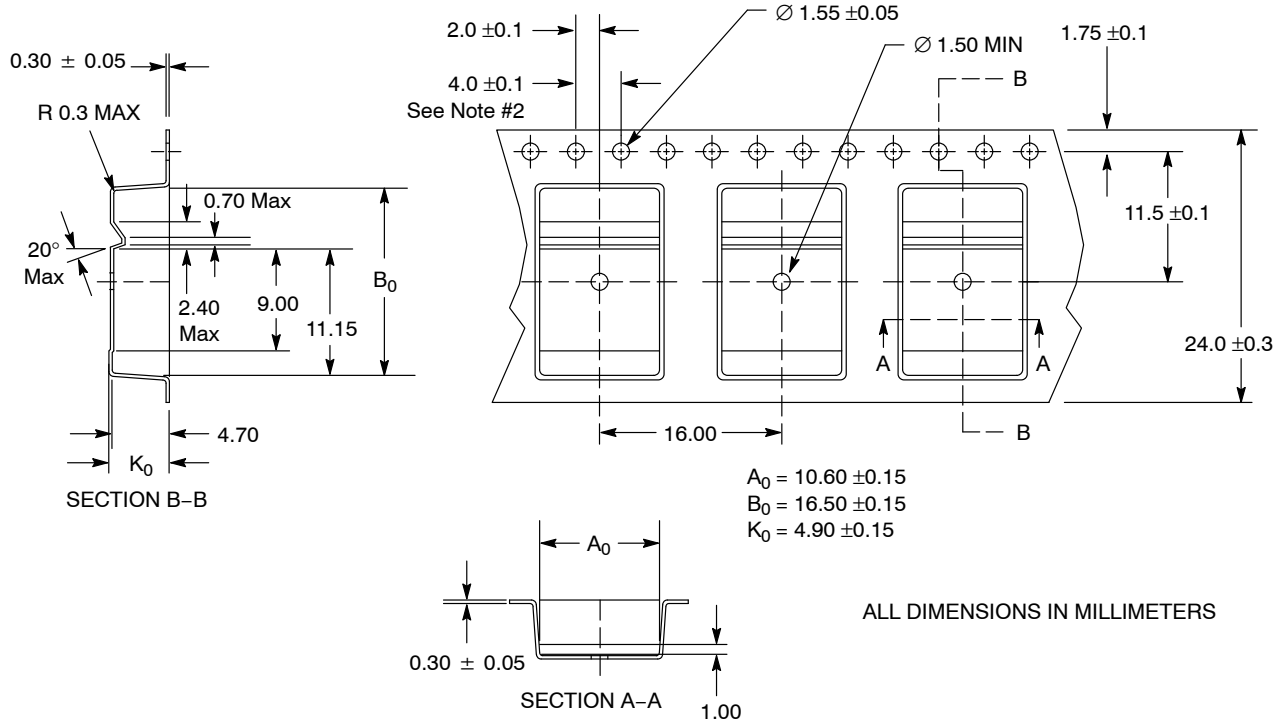

Figure 11. 3-Pin and 5-Pin D²PAK Thermal Resistance and Maximum Power Dissipation versus P.C.B. Copper Length

NCP630

TAPE AND REEL SPECIFICATION

SOP Description	Leads	Package Length	Package Width	Package Thickness	Reel Quantity	Tape Pitch	Tape Width	Vendor P/N
D ² PAK	5	9.2 mm	10 mm	4.4 mm	800	16 mm	24 mm	DDPAK-B



NOTES:

1. A_0 & B_0 MEASURED AT 0.3 mm ABOVE BASE OF POCKET
2. 10 PITCHES CUMULATIVE TOTAL ± 0.2 mm

Figure 12. Package Carrier Dimensions

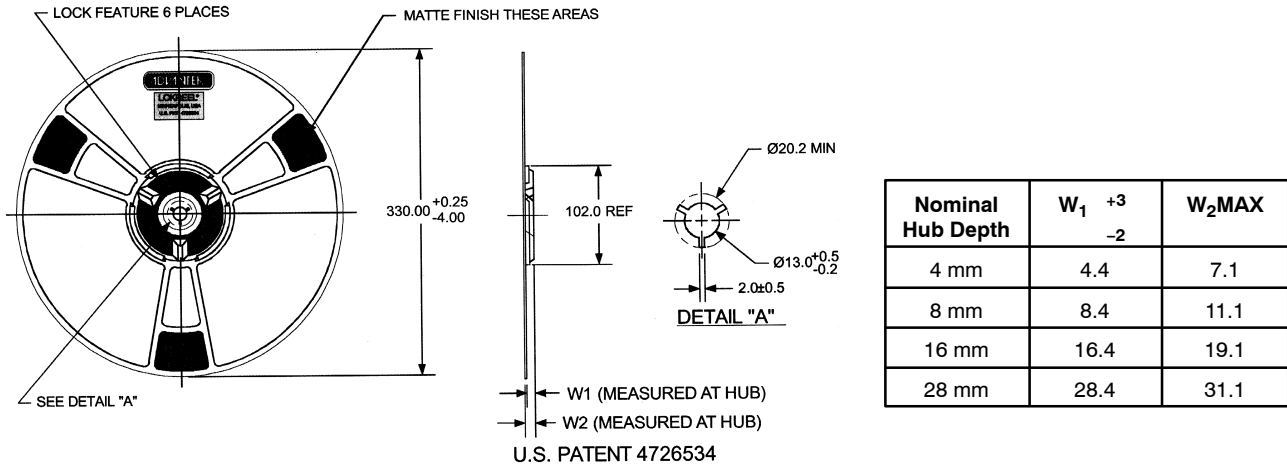

Figure 13. Reel Dimensions

NCP630

ORDERING INFORMATION

Device	Nominal Output Voltage	Package	Shipping
NCP630AD2T	Adj	D ² PAK	50 Units/Rail
NCP630AD2TG	Adj	D ² PAK (Pb-Free)	50 Units/Rail
NCP630AD2TR4	Adj	D ² PAK	800/Tape & Reel
NCP630AD2TR4G	Adj	D ² PAK (Pb-Free)	800/Tape & Reel
NCP630GD2T	3.47	D ² PAK	50 Units/Rail
NCP630GD2TG	3.47	D ² PAK (Pb-Free)	50 Units/Rail
NCP630GD2TR4	3.47	D ² PAK	800/Tape & Reel
NCP630GD2TR4G	3.47	D ² PAK (Pb-Free)	800/Tape & Reel

MECHANICAL CASE OUTLINE

PACKAGE DIMENSIONS

ON Semiconductor®

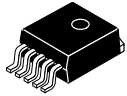

SCALE 1:1

D²PAK 5-LEAD CASE 936A-02 ISSUE D

DATE 15 SEP 2015

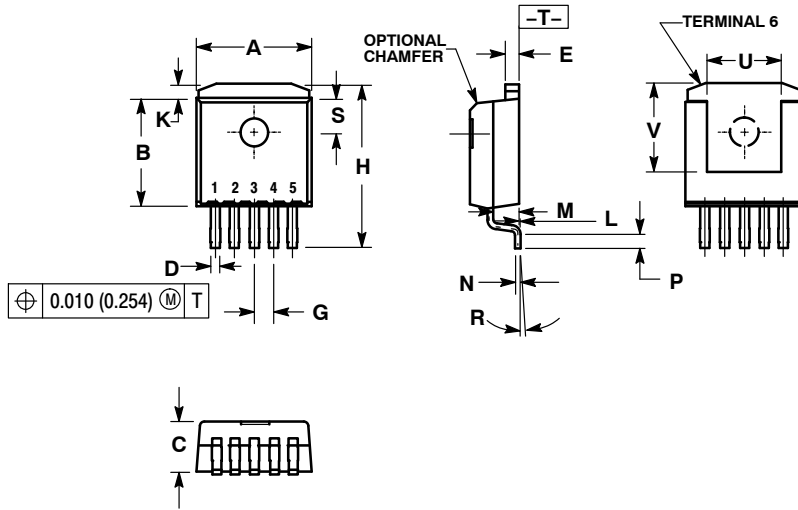

NOTES:

- DIMENSIONING AND TOLERANCING PER ANSI Y14.5M, 1982.
- CONTROLLING DIMENSION: INCH.
- TAB CONTOUR OPTIONAL WITHIN DIMENSIONS A AND K.
- DIMENSIONS U AND V ESTABLISH A MINIMUM MOUNTING SURFACE FOR TERMINAL 6.
- DIMENSIONS A AND B DO NOT INCLUDE MOLD FLASH OR GATE PROTRUSIONS. MOLD FLASH AND GATE PROTRUSIONS NOT TO EXCEED 0.025 (0.635) MAXIMUM.

DIM	INCHES		MILLIMETERS	
	MIN	MAX	MIN	MAX
A	0.386	0.403	9.804	10.236
B	0.356	0.368	9.042	9.347
C	0.170	0.180	4.318	4.572
D	0.026	0.036	0.660	0.914
E	0.045	0.055	1.143	1.397
G	0.067 BSC		1.702 BSC	
H	0.539	0.579	13.691	14.707
K	0.050 REF		1.270 REF	
L	0.000	0.010	0.000	0.254
M	0.088	0.102	2.235	2.591
N	0.018	0.026	0.457	0.660
P	0.058	0.078	1.473	1.981
R	0°	8°	0°	8°
S	0.116 REF		2.946 REF	
U	0.200 MIN		5.080 MIN	
V	0.250 MIN		6.350 MIN	

SOLDERING FOOTPRINT

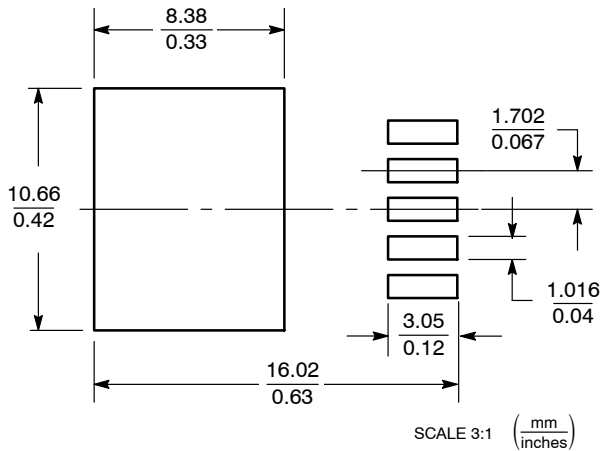

GENERIC MARKING DIAGRAM*

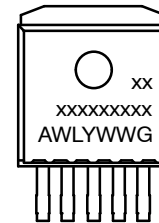

- xxxxxx = Device Code
- A = Assembly Location
- WL = Wafer Lot
- Y = Year
- WW = Work Week
- G = Pb-Free Package

*This information is generic. Please refer to device data sheet for actual part marking. Pb-Free indicator, "G" or microdot "▪", may or may not be present.

DOCUMENT NUMBER:	98ASH01006A	Electronic versions are uncontrolled except when accessed directly from the Document Repository. Printed versions are uncontrolled except when stamped "CONTROLLED COPY" in red.
DESCRIPTION:	D2PAK 5-LEAD	PAGE 1 OF 1

ON Semiconductor and are trademarks of Semiconductor Components Industries, LLC dba ON Semiconductor or its subsidiaries in the United States and/or other countries. ON Semiconductor reserves the right to make changes without further notice to any products herein. ON Semiconductor makes no warranty, representation or guarantee regarding the suitability of its products for any particular purpose, nor does ON Semiconductor assume any liability arising out of the application or use of any product or circuit, and specifically disclaims any and all liability, including without limitation special, consequential or incidental damages. ON Semiconductor does not convey any license under its patent rights nor the rights of others.

ON Semiconductor and  are trademarks of Semiconductor Components Industries, LLC dba ON Semiconductor or its subsidiaries in the United States and/or other countries. ON Semiconductor owns the rights to a number of patents, trademarks, copyrights, trade secrets, and other intellectual property. A listing of ON Semiconductor's product/patent coverage may be accessed at www.onsemi.com/site/pdf/Patent-Marking.pdf. ON Semiconductor reserves the right to make changes without further notice to any products herein. ON Semiconductor makes no warranty, representation or guarantee regarding the suitability of its products for any particular purpose, nor does ON Semiconductor assume any liability arising out of the application or use of any product or circuit, and specifically disclaims any and all liability, including without limitation special, consequential or incidental damages. Buyer is responsible for its products and applications using ON Semiconductor products, including compliance with all laws, regulations and safety requirements or standards, regardless of any support or applications information provided by ON Semiconductor. "Typical" parameters which may be provided in ON Semiconductor data sheets and/or specifications can and do vary in different applications and actual performance may vary over time. All operating parameters, including "Typicals" must be validated for each customer application by customer's technical experts. ON Semiconductor does not convey any license under its patent rights nor the rights of others. ON Semiconductor products are not designed, intended, or authorized for use as a critical component in life support systems or any FDA Class 3 medical devices or medical devices with a same or similar classification in a foreign jurisdiction or any devices intended for implantation in the human body. Should Buyer purchase or use ON Semiconductor products for any such unintended or unauthorized application, Buyer shall indemnify and hold ON Semiconductor and its officers, employees, subsidiaries, affiliates, and distributors harmless against all claims, costs, damages, and expenses, and reasonable attorney fees arising out of, directly or indirectly, any claim of personal injury or death associated with such unintended or unauthorized use, even if such claim alleges that ON Semiconductor was negligent regarding the design or manufacture of the part. ON Semiconductor is an Equal Opportunity/Affirmative Action Employer. This literature is subject to all applicable copyright laws and is not for resale in any manner.

PUBLICATION ORDERING INFORMATION

LITERATURE FULFILLMENT:

Email Requests to: orderlit@onsemi.com

ON Semiconductor Website: www.onsemi.com

TECHNICAL SUPPORT

North American Technical Support:
Voice Mail: 1 800-282-9855 Toll Free USA/Canada
Phone: 011 421 33 790 2910

Europe, Middle East and Africa Technical Support:

Phone: 00421 33 790 2910

For additional information, please contact your local Sales Representative