

## N-Channel 20-V (D-S) MOSFET

PRODUCT SUMMARY		
$V_{DS}$ (V)	$r_{DS(on)}$ ( $\Omega$ )	$I_D$ (A)
20	0.008 @ $V_{GS} = 10$ V	17
	0.012 @ $V_{GS} = 4.5$ V	14

### FEATURES

- TrenchFET® Power MOSFET
- New Low Thermal Resistance PowerPAK® Package with Low 1.07-mm Profile
- PWM Optimized



Available  
**RoHS\***  
COMPLIANT

### APPLICATIONS

- DC/DC conversion High-Side
  - Desktop
  - Server
- Synchronous Rectification

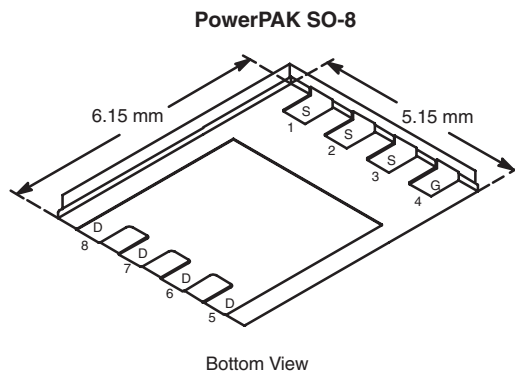

Ordering Information: Si7344DP-T1  
Si7344DP-T1—E3 (Lead (Pb)-Free)

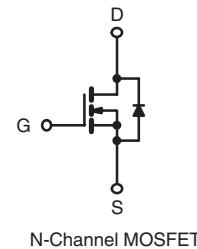

ABSOLUTE MAXIMUM RATINGS $T_A = 25^\circ\text{C}$ , unless otherwise noted				
Parameter	Symbol	10 secs	Steady State	Unit
Drain-Source Voltage	$V_{DS}$	20		V
Gate-Source Voltage	$V_{GS}$	$\pm 20$		V
Continuous Drain Current ( $T_J = 150^\circ\text{C}$ ) <sup>a</sup>	$I_D$	$T_A = 25^\circ\text{C}$	17	11
		$T_A = 70^\circ\text{C}$	14	9
Pulsed Drain Current (10 $\mu\text{s}$ Pulse Width)	$I_{DM}$	50		A
Continuous Source Current (Diode Conduction) <sup>a</sup>	$I_S$	3.7	1.6	
Maximum Power Dissipation <sup>a</sup>	$P_D$	$T_A = 25^\circ\text{C}$	4.1	1.8
		$T_A = 70^\circ\text{C}$	2.6	1.1
Operating Junction and Storage Temperature Range	$T_J, T_{stg}$	-55 to 150		$^\circ\text{C}$
Soldering Recommendations (Peak Temperature) <sup>b,c</sup>		260		

THERMAL RESISTANCE RATINGS					
Parameter	Symbol	Typical	Maximum	Unit	
Maximum Junction-to-Ambient <sup>a</sup>	$R_{thJA}$	$t \leq 10$ sec	22	30	$^\circ\text{C/W}$
		Steady State	55	70	
Maximum Junction-to-Case (Drain)	$R_{thJC}$	4.5	5.5		

Notes

- a. Surface Mounted on 1" x 1" FR4 Board.  
 b. See Solder Profile (<http://www.vishay.com/ppg?73257>). The PowerPAK SO-8 is a leadless package. The end of the lead terminal is exposed copper (not plated) as a result of the singulation process in manufacturing. A solder fillet at the exposed copper tip cannot be guaranteed and is not required to ensure adequate bottom side solder interconnection.  
 c. Rework Conditions: manual soldering with a soldering iron is not recommended for leadless components.

\* Pb containing terminations are not RoHS compliant, exemptions may apply.

<b>SPECIFICATIONS</b> $T_J = 25^\circ\text{C}$ , unless otherwise noted						
Parameter	Symbol	Test Condition	Min	Typ	Max	Unit
<b>Static</b>						
Gate Threshold Voltage	$V_{GS(th)}$	$V_{DS} = V_{GS}, I_D = 250\ \mu\text{A}$	0.8		2.1	V
Gate-Body Leakage	$I_{GSS}$	$V_{DS} = 0\ \text{V}, V_{GS} = \pm 20\ \text{V}$			$\pm 100$	nA
Zero Gate Voltage Drain Current	$I_{DSS}$	$V_{DS} = 20\ \text{V}, V_{GS} = 0\ \text{V}$			1	$\mu\text{A}$
		$V_{DS} = 20\ \text{V}, V_{GS} = 0\ \text{V}, T_J = 55^\circ\text{C}$			5	
On-State Drain Current <sup>a</sup>	$I_{D(on)}$	$V_{DS} \geq 5\ \text{V}, V_{GS} = 10\ \text{V}$	30			A
Drain-Source On-State Resistance <sup>a</sup>	$r_{DS(on)}$	$V_{GS} = 10\ \text{V}, I_D = 17\ \text{A}$		0.006	0.008	$\Omega$
		$V_{GS} = 4.5\ \text{V}, I_D = 14\ \text{A}$		0.0095	0.012	
Forward Transconductance <sup>a</sup>	$g_{fs}$	$V_{DS} = 6\ \text{V}, I_D = 17\ \text{A}$		33		S
Diode Forward Voltage <sup>a</sup>	$V_{SD}$	$I_S = 3.7\ \text{A}, V_{GS} = 0\ \text{V}$		0.75	1.1	V
<b>Dynamic<sup>b</sup></b>						
Total Gate Charge	$Q_g$	$V_{DS} = 10\ \text{V}, V_{GS} = 4.5\ \text{V}, I_D = 17\ \text{A}$		10	15	nC
Gate-Source Charge	$Q_{gs}$		3.3			
Gate-Drain Charge	$Q_{gd}$		3.1			
Gate Resistance	$R_g$			1.0		$\Omega$
Turn-On Delay Time	$t_{d(on)}$	$V_{DD} = 10\ \text{V}, R_L = 10\ \Omega$ $I_D \cong 1\ \text{A}, V_{GEN} = 10\ \text{V}, R_G = 6\ \Omega$		14	25	ns
Rise Time	$t_r$		15	25		
Turn-Off Delay Time	$t_{d(off)}$		40	65		
Fall Time	$t_f$		15	25		
Source-Drain Reverse Recovery Time	$t_{rr}$	$I_F = 3.7\ \text{A}, di/dt = 100\ \text{A}/\mu\text{s}$		35	70	

**Notes**

- a. Pulse test; pulse width  $\leq 300\ \mu\text{s}$ , duty cycle  $\leq 2\%$ .
- b. Guaranteed by design, not subject to production testing.

Stresses beyond those listed under "Absolute Maximum Ratings" may cause permanent damage to the device. These are stress ratings only, and functional operation of the device at these or any other conditions beyond those indicated in the operational sections of the specifications is not implied. Exposure to absolute maximum rating conditions for extended periods may affect device reliability.

**TYPICAL CHARACTERISTICS**  $25^\circ\text{C}$  unless noted

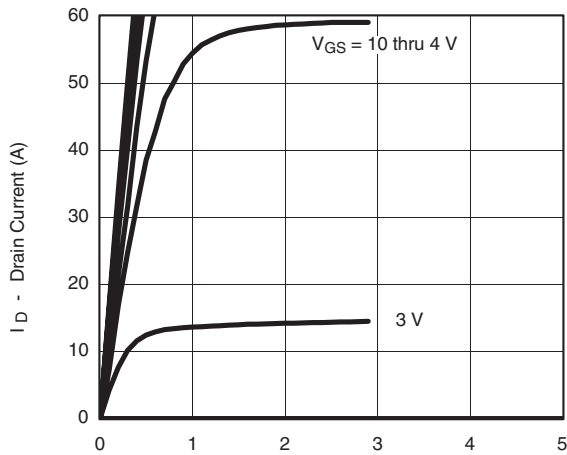

**Output Characteristics**

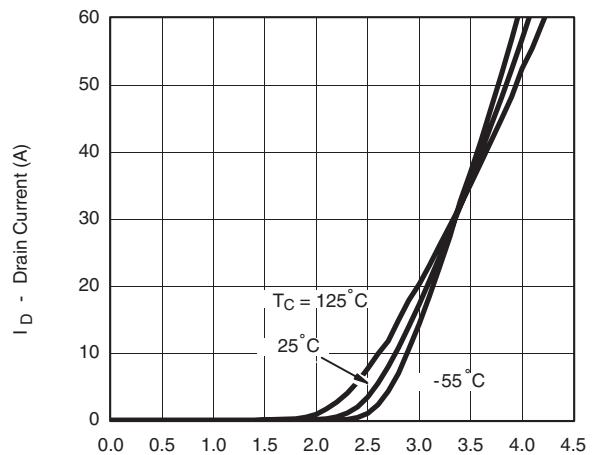

**Transfer Characteristics**

**TYPICAL CHARACTERISTICS** 25 °C unless noted

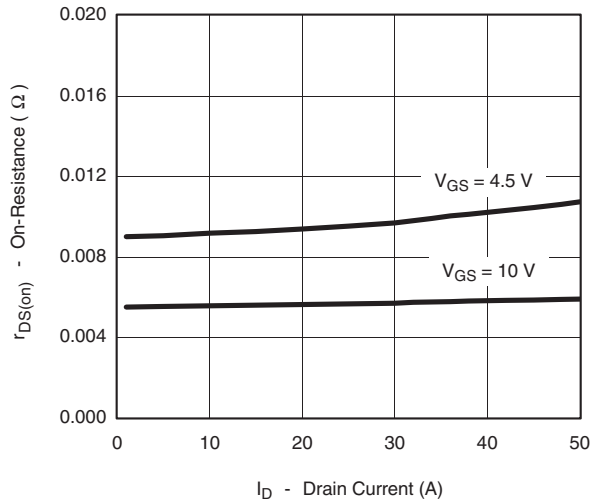

**On-Resistance vs. Drain Current**

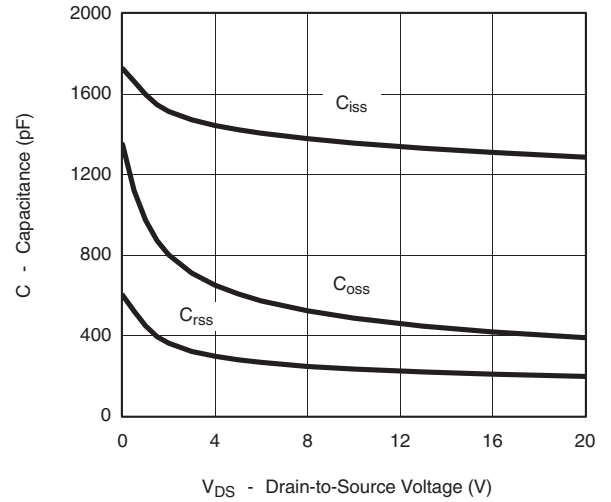

**Capacitance**

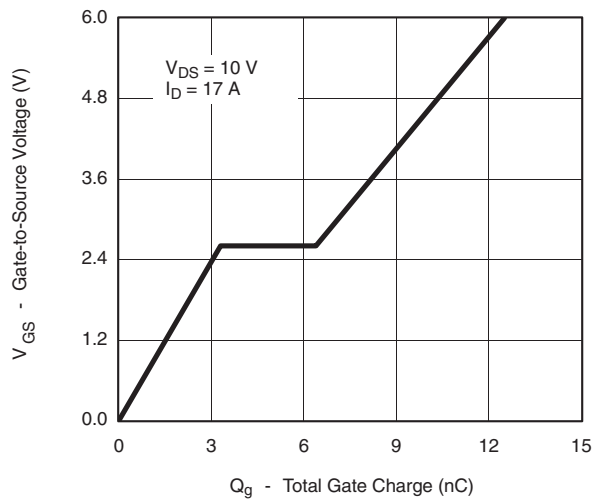

**Gate Charge**

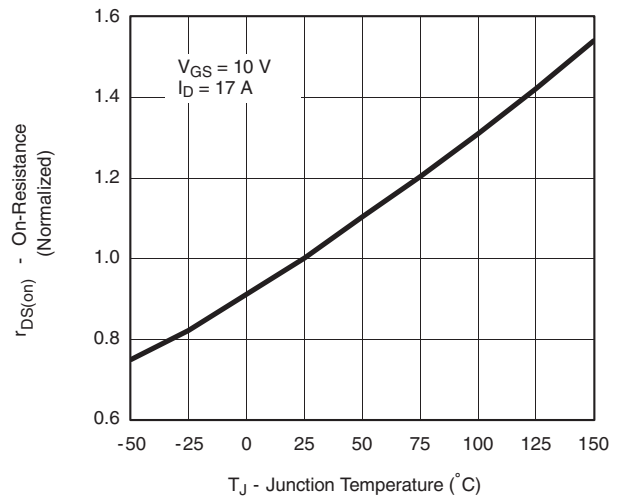

**On-Resistance vs. Junction Temperature**

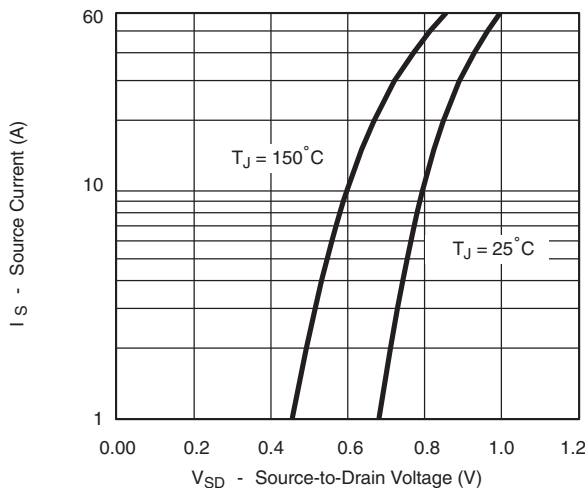

**Source-Drain Diode Forward Voltage**

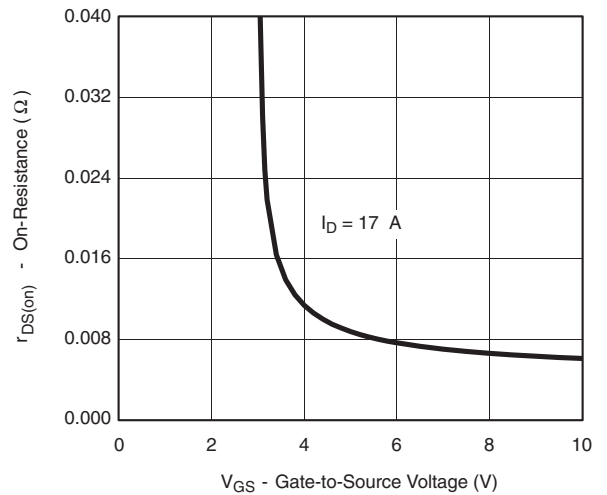

**On-Resistance vs. Gate-to-Source Voltage**

**TYPICAL CHARACTERISTICS** 25 °C unless noted

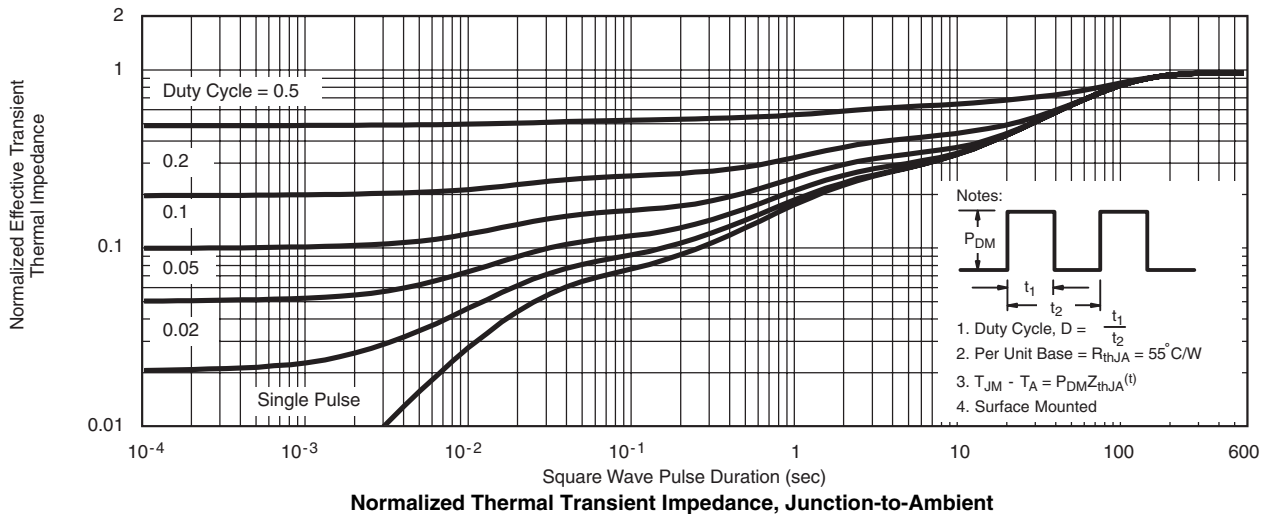
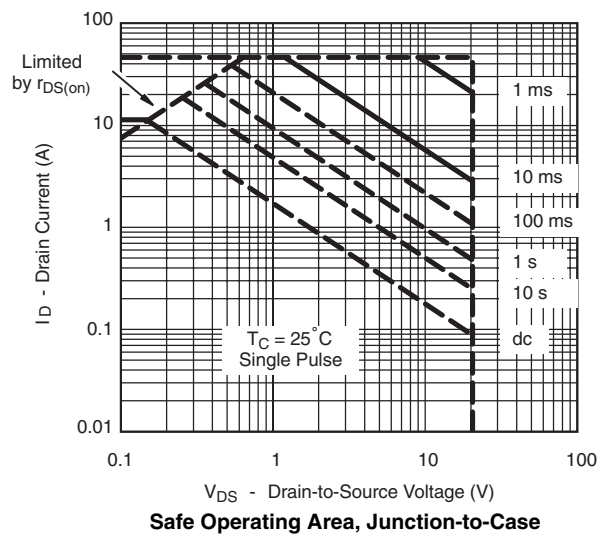
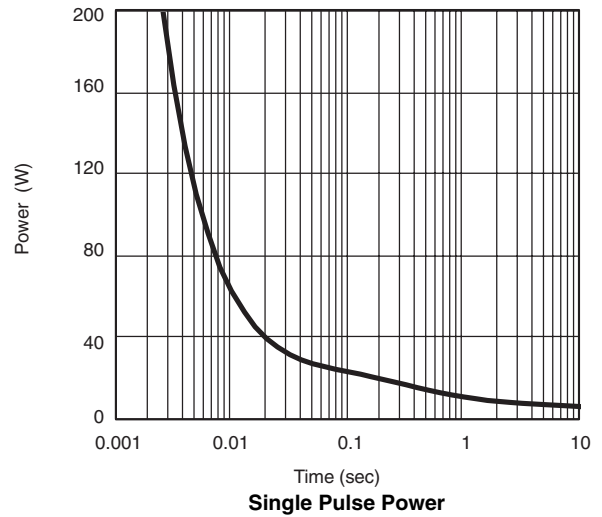
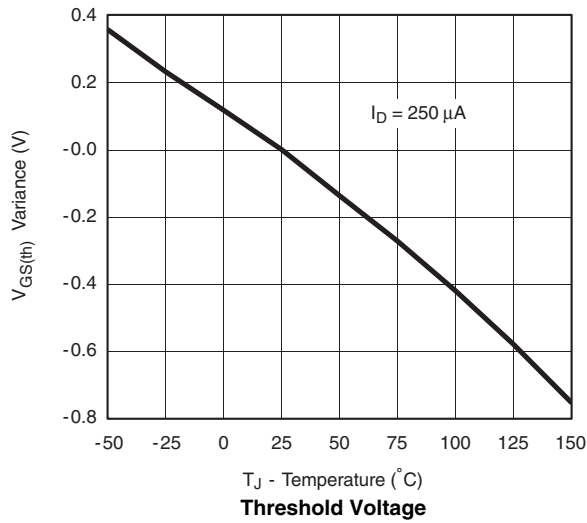

**TYPICAL CHARACTERISTICS** 25 °C unless noted

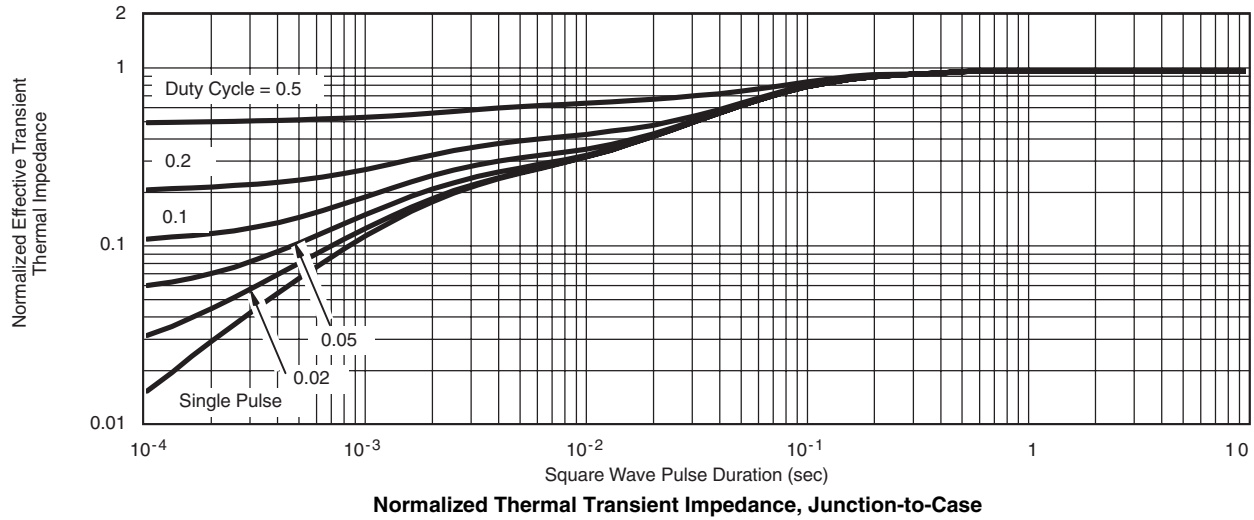

Vishay Siliconix maintains worldwide manufacturing capability. Products may be manufactured at one of several qualified locations. Reliability data for Silicon Technology and Package Reliability represent a composite of all qualified locations. For related documents such as package/tape drawings, part marking, and reliability data, see <http://www.vishay.com/ppg?72128>.



## Disclaimer

All product specifications and data are subject to change without notice.

Vishay Intertechnology, Inc., its affiliates, agents, and employees, and all persons acting on its or their behalf (collectively, "Vishay"), disclaim any and all liability for any errors, inaccuracies or incompleteness contained herein or in any other disclosure relating to any product.

Vishay disclaims any and all liability arising out of the use or application of any product described herein or of any information provided herein to the maximum extent permitted by law. The product specifications do not expand or otherwise modify Vishay's terms and conditions of purchase, including but not limited to the warranty expressed therein, which apply to these products.

No license, express or implied, by estoppel or otherwise, to any intellectual property rights is granted by this document or by any conduct of Vishay.

The products shown herein are not designed for use in medical, life-saving, or life-sustaining applications unless otherwise expressly indicated. Customers using or selling Vishay products not expressly indicated for use in such applications do so entirely at their own risk and agree to fully indemnify Vishay for any damages arising or resulting from such use or sale. Please contact authorized Vishay personnel to obtain written terms and conditions regarding products designed for such applications.

Product names and markings noted herein may be trademarks of their respective owners.