

Helping Customers Innovate, Improve & Grow



## Description

Vectron's VCC1 Crystal Oscillator (XO) is a quartz stabilized square wave generator with a CMOS output. The VCC1 uses a fundamental or 3rd overtone crystal resulting in very low jitter performance, and a monolithic IC which improves reliability and reduces cost.

## Features

- Ultra Low Jitter, Fundamental or 3rd OT Crystal Design
- CMOS Output Crystal Oscillator
- Output Frequencies from 1.024 MHz to 190.000 MHz
- 5.0, 3.3, 2.5 or 1.8 V Operation
- Output Disable Feature
- Excellent 20ppm temperature stability
- -10/70°C, -40/85°C or -55/125°C operating temperature
- Small Industry Standard Package, 7 x 5 mm
- Product is compliant to RoHS directive  and fully compatible with lead free assembly

## Applications

- SONET/SDH/DWDM
- Ethernet, GE, SynchE
- Storage Area Networking
- Fiber Channel
- Digital Video
- Broadband Access
- Base Stations, Picocells
- Driving A/D's, D/A's, FPGA's
- Test and Measurement
- COTS

## Block Diagram



**Table 1. Electrical Performance, 5V Option**

Parameter	Symbol	Minimum	Typical	Maximum	Units
<b>Supply</b>					
Voltage <sup>1</sup>	$V_{DD}$	4.5	5.0	5.5	V
Max Voltage		-0.7		7	V
Current <sup>2</sup> ≤20.000MHz 20.001 to 50.000MHz 50.001 to 85.000MHz 85.001 to 125.000MHz	$I_{DD}$			10 30 50 60	mA
Current, Output Disabled				30	uA
<b>Frequency</b>					
Nominal Frequency <sup>3</sup>	$f_N$	1.544		125.000	MHz
Stability <sup>4</sup> , (Ordering Option)		±20, ±25, ±32, ±50, ±100			ppm
<b>Outputs</b>					
Output Logic Levels <sup>2</sup> Output Logic High Output Logic Low Output Logic High Drive Output Logic Low Drive	$V_{OH}$ $V_{OL}$ $I_{OH}$ $I_{OL}$	0.9* $V_{DD}$  16 16		0.1* $V_{DD}$	V V mA mA
Load	$I_{OUT}$			15	pF
Output Rise /Fall Time <sup>2</sup> <20.000MHz 20.000 to 50.000MHz 50.001 to 125.000MHz	$t_R/t_F$			8 5 2	ns
Output Leakage, Output Disabled	$I_Z$			±10	uA
Duty Cycle <sup>2,5</sup>		45	50	55	%
Period Jitter <sup>6</sup> RMS Peak-Peak	$\phi_J$		2.5 18		ps
RMS Jitter, 12k-20MHz	$\phi_J$		0.5	1	ps
<b>Enable/Disable</b>					
Output Enable/Disable <sup>7</sup> Output Enable Output Disable	$V_{IH}$ $V_{IL}$	4.0		0.8	V V
Disable time	$t_D$			100	ns
Enable Internal Pull-Up Resistor			100		Kohm
Start-Up Time	$t_{SU}$			10	ms
Operating Temp, (Ordering Option)	$T_{OP}$	-10/70, -40/85, -55/125			°C

1] The power supply should have by-pass capacitors as close to the supply and to ground as possible, for example 0.1 and 0.01 uF.

2] Parameters are tested with the test circuit shown in Figure 1.

3] See Standard Frequencies and Ordering Information tables for more specific information.

4] Includes initial accuracy, operating temperature, supply voltage, shock and vibration (not under operation) and 10 years aging.

5] Duty Cycle is measured as On Time/Period, see Fig 2.

6] Broadband Period Jitter measured using a LeCroy Wavemaster 8600A, 90K samples, see Application Note for Typical Phase Noise and Jitter Performance.

7] The Output is Enabled if the Enable/Disable is left open.

**Table 2. Electrical Performance, 3.3V Option**

Parameter	Symbol	Minimum	Typical	Maximum	Units
<b>Supply</b>					
Voltage <sup>1</sup>	$V_{DD}$	2.97	3.3	3.63	V
Maximum Voltage		-0.5		5	V
Current <sup>2</sup> ≤20.000 20.001 to 50.000 50.001 to 85.000 85.001 to 190.000	$I_{DD}$			7 20 30 50	mA
Current, Output Disabled				30	uA
<b>Frequency</b>					
Nominal Frequency <sup>3</sup>	$f_N$	1.024		190.000	MHz
Stability <sup>4</sup> , (Ordering Option)		±20, ±25, ±32, ±50, ±100			ppm
<b>Outputs</b>					
Output Logic Levels <sup>2</sup> Output Logic High Output Logic Low Output Logic High Drive Output Logic Low Drive	$V_{OH}$ $V_{OL}$ $I_{OH}$ $I_{OL}$	0.9* $V_{DD}$  8 8		0.1* $V_{DD}$	V V mA mA
Load	$I_{OUT}$			15	pF
Output Rise /Fall Time <sup>2</sup> <20.000MHz 20.000 to 50.000MHz 50.001 to 90.000MHz 90.001 to 190.000MHz	$t_R/t_F$			6 4 3 2	ns
Output Leakage, Output Disabled <sup>2,5</sup>	$I_z$			±10	uA
Duty Cycle <sup>2,5</sup>		45	50	55	%
Period Jitter <sup>6</sup> RMS Peak-Peak	$\phi_J$		2.5 18		ps
RMS Jitter, 12k-20M	$\phi_J$		0.5	1	ps
<b>Enable/Disable</b>					
Output Enable/Disable <sup>7</sup> Output Enable Output Disable	$V_{IH}$ $V_{IL}$	2.0		0.5	V V
Disable time	$t_D$			100	ns
Enable Internal Pull-Up Resistor			100		Kohm
Start-Up Time	$t_{SU}$			10	ms
Operating Temp, (Ordering Option)	$T_{OP}$	-10/70, -40/85, -55/125			°C

1] The power supply should have by-pass capacitors as close to the supply and to ground as possible, for example 0.1 and 0.01uF.

2] Parameters are tested with the test circuit shown in Figure 1.

3] See Standard Frequencies and Ordering Information tables for more specific information.

4] Includes initial accuracy, operating temperature, supply voltage, shock and vibration (not under operation) and 10 years aging.

5] Duty Cycle is measured as On Time/Period, see Fig 2.

6] Broadband Period Jitter measured using a LeCroy Wavemaster 8600A, 90K samples, see Application Note for Typical Phase Noise and Jitter Performance.

7] The Output is Enabled if the Enable/Disable is left open.

**Table 3. Electrical Performance, 2.5V Option**

Parameter	Symbol	Minimum	Typical	Maximum	Units
<b>Supply</b>					
Voltage <sup>1</sup>	$V_{DD}$	2.25	2.5	2.75	V
Maximum Voltage		-0.5		5	V
Current <sup>2</sup> ≤20.000MHz 20.001 to 50.000MHz 50.001 to 110.000MHz 110.001 to 190.000MHz	$I_{DD}$			7 15 20 30	mA
Current, Output Disabled				30	uA
<b>Frequency</b>					
Nominal Frequency <sup>3</sup>	$f_N$	1.544		190.000	MHz
Stability <sup>4</sup> , (Ordering Option)		±20, ±25, ±32, ±50, ±100			ppm
<b>Outputs</b>					
Output Logic Levels <sup>2,3</sup> Output Logic High Output Logic Low Output Logic High Drive Output Logic Low Drive Output Logic High Drive <sup>5</sup> Output Logic Low Drive <sup>5</sup>	$V_{OH}$ $V_{OL}$ $I_{OH}$ $I_{OL}$	0.9* $V_{DD}$ 4 4 8 8		0.1* $V_{DD}$	V V mA mA mA mA
Load	$I_{OUT}$			15	pF
Output Rise /Fall Time <sup>2</sup> <20.000MHz 20.000 to 50.000MHz 50.001 to 90.000MHz 90.001 to 190.000MHz	$t_R/t_F$			10 6 3 2	ns
Output Leakage, Output Disabled				±10	uA
Duty Cycle <sup>2,6</sup>		45	50	55	%
Period Jitter <sup>7</sup> RMS Peak-Peak	$\phi_J$		2.5 18		ps
RMS Jitter, 12k-20MHz	$\phi_J$		0.5	1	ps
<b>Enable/Disable</b>					
Output Enable/Disable <sup>8</sup> Output Enable Output Disable	$V_{IH}$ $V_{IL}$	1.75		0.5	V V
Disable time	$t_D$			100	ns
Enable Internal Pull-Up Resistor			100		Kohm
Start-Up Time	$t_{SU}$			10	ms
Operating Temp, (Ordering Option)	$T_{OP}$	-10/70, -40/85, -55/125			°C

1] The power supply should have by-pass capacitors as close to the supply and to ground as possible, for example 0.1 and 0.01uF.

2] Parameters are tested with the test circuit shown in Figure 1.

3] See Standard Frequencies and Ordering Information tables for more specific information.

4] Includes initial accuracy, operating temperature, supply voltage, shock and vibration (not under operation) and 10 years aging.

5] Output Frequencies > 35MHz.

6] Duty Cycle is measured as On Time/Period, see Fig 2.

7] Broadband Period Jitter measured using a LeCroy Wavemaster 8600A, 90K samples, see Application Note for Typical Phase Noise and Jitter Performance.

8] The Output is Enabled if the Enable/Disable is left open.

**Table 4. Electrical Performance, 1.8V Option**

Parameter	Symbol	Minimum	Typical	Maximum	Units
<b>Supply</b>					
Voltage <sup>1</sup>	$V_{DD}$	1.71	1.8	1.89	V
Maximum Voltage		-0.5		3.6	V
Current <sup>2</sup> ≤20.000MHz 20.001 to 70.000MHz 70.001 to 96.000MHz 96.001 to 125.000MHz 125.001 to 172.000MHz	$I_{DD}$			5 15 20 25 30	mA
Current, Output Disabled				30	uA
<b>Frequency</b>					
Nominal Frequency <sup>3</sup>	$f_N$	1.544		172.000	MHz
Stability <sup>4</sup> , (Ordering Option)		±20, ±25, ±32, ±50, ±100			ppm
<b>Outputs</b>					
Output Logic Levels <sup>2,3</sup> Output Logic High Output Logic Low Output Logic High Drive Output Logic Low Drive Output Logic High Drive <sup>5</sup> Output Logic Low Drive <sup>5</sup>	$V_{OH}$ $V_{OL}$ $I_{OH}$ $I_{OL}$ $I_{OH}$ $I_{OL}$	0.9* $V_{DD}$  2.8 2.8 8 8		0.1* $V_{DD}$	V V mA mA
Load	$I_{OUT}$			15	pF
Output Rise /Fall Time <sup>2</sup> <20.000MHz 20.000 to 50.000MHz 50.001 to 90.000MHz 90.000 to 172.000MHz	$t_R/t_F$			4 4 3 2	ns
Output Leakage, Output Disabled	$I_z$			±10	uA
Duty Cycle <sup>2,6</sup>		45	50	55	%
Period Jitter <sup>7</sup> RMS Peak-to-peak	$\phi_J$		2.5 18		ps
RMS Jitter, 12kHz-20MHz	$\phi_J$		0.5	1	ps
<b>Enable/Disable</b>					
Output Enable/Disable <sup>8</sup> Output Enable Output Disable	$V_{IH}$ $V_{IL}$	1.26		0.5	V V
Disable time	$t_D$			100	ns
Enable Internal Pull-Up Resistor			1		Mohm
Start-Up Time	$t_{SU}$			10	ms
Operating Temp, Ordering Option	$T_{OP}$	-10/70, -40/85, -55/125			°C

1] The power supply should have by-pass capacitors as close to the supply and to ground as possible, for example 0.1 and 0.01uF.

2] Parameters are tested with the test circuit shown in Figure 1.

3] See Standard Frequencies and Ordering Information tables for more specific information.

4] Includes initial accuracy, operating temperature, supply voltage, shock and vibration (not under operation) and 10 years aging.

5] Output Frequencies > 35MHz.

6] Duty Cycle is measured as On Time/Period, see Fig 2.

7] Broadband Period Jitter measured using a LeCroy Wavemaster 8600A, 90K samples, see Application Note for Typical Phase Noise and Jitter Performance.

8] The Output is Enabled if the Enable/Disable is left open.

## Test Diagram and Waveform

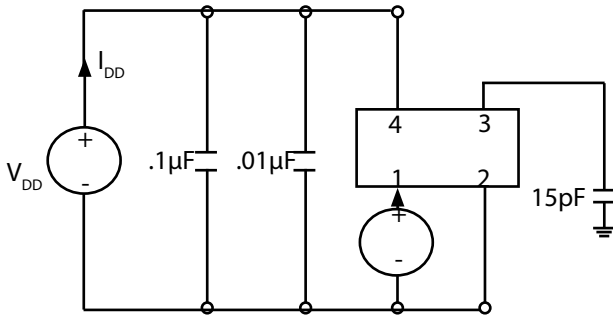
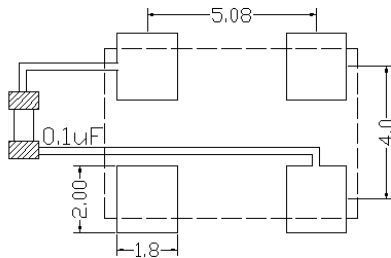
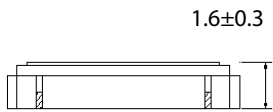
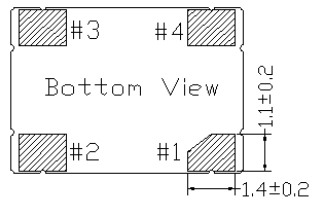
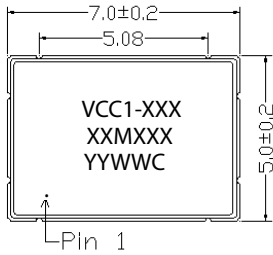

Fig 1: Test Circuit



Fig 2: Waveform

## Outline Drawing & Pad Layout



Recommended Soldering Pad Layout

Dimensions in mm

Table 5. Pin Out

Pin	Symbol	Function
1	E/D	Enable Disable
2	GND	Case and Electrical Ground
3	Output	Output
4	V <sub>DD</sub>	Power Supply Voltage

Table 6. Enable Disable Function

E/D Pin	Output
High	Clock Output
Open	Clock Output
Low	High Impedance

## Reliability

Vectron qualification includes aging at various extreme temperatures, shock and vibration, temperature cycling, and IR reflow simulation. The VCC1 family is capable of meeting the following qualification tests:

**Table 7. Environmental Compliance**

Parameter	Conditions
Mechanical Shock	MIL-STD-883, Method 2002
Mechanical Vibration	MIL-STD-883, Method 2007
Temperature Cycle	MIL-STD-883, Method 1010
Solderability	MIL-STD-883, Method 2003
Gross and Fine Leak	MIL-STD-883, Method 1014
Resistance to Solvents	MIL-STD-883, Method 2015
Moisture Sensitivity Level	MSL 1
Contact Pads	Gold (0.3 um min to 1.0 um max) over Nickel
Weight	178 mg

Although ESD protection circuitry has been designed into the VCC1 proper precautions should be taken when handling and mounting. Vectron employs a human body model (HBM) and a charged device model (CDM) for ESD susceptibility testing and design protection evaluation.

**Table 8. ESD Ratings**

Model	Minimum	Conditions
Human Body Model	1500V	MIL-STD-883, Method 3015
Charged Device Model	1000V	JESD22-C101

Stresses in excess of the absolute maximum ratings can permanently damage the device. Functional operation is not implied at these or any other conditions in excess of conditions represented in the operational sections of this datasheet. Exposure to absolute maximum ratings for extended periods may adversely affect device reliability. Permanent damage is also possible if E/D is applied before  $V_{DD}$ .

**Table 9. Absolute Maximum Ratings**

Parameter	Symbol	Ratings	Unit
Storage Temperature	$T_S$	-55 to 125	°C
Soldering Temp/Time	$T_{LS}$	260 / 30	°C / sec

# IR Reflow

The VCC1 is qualified to meet the JEDEC standard for Pb-Free assembly. The temperatures and time intervals listed are based on the Pb-Free small body requirements. The VCC1 device is hermetically sealed so an aqueous wash is not an issue.

## Solderprofile:

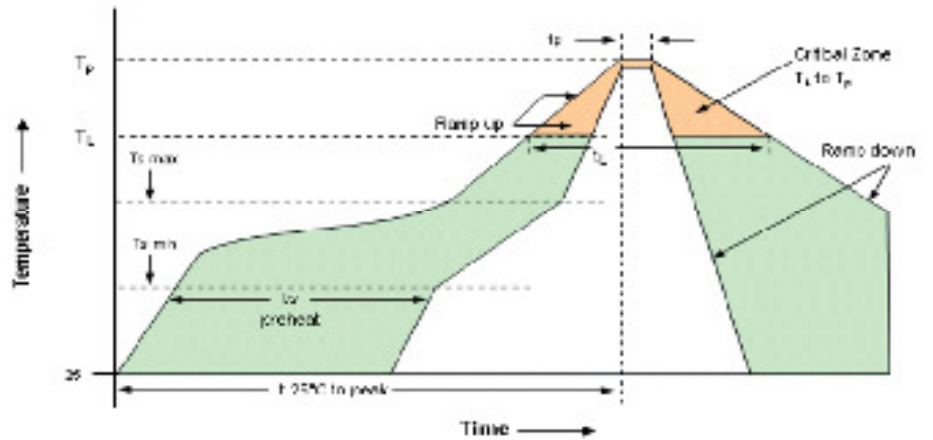

**Table 10. Reflow Profile**

Parameter	Symbol	Value
PreHeat Time Ts-min Ts-max	$t_s$	60 sec Min, 260 sec Max 150°C 200°C
Ramp Up	$R_{UP}$	3 °C/sec Max
Time Above 217 °C	$t_L$	60 sec Min, 150 sec Max
Time To Peak Temperature	$T_{AMB-P}$	480 sec Max
Time at 260 °C	$t_p$	30 sec Max
Ramp Down	$R_{DN}$	6 °C/sec Max

# Tape and Reel



**Table 11. Tape and Reel Information**

Tape Dimensions (mm)						Reel Dimensions (mm)							# Per Reel
Dimension	W	F	Do	Po	P1	A	B	C	D	N	W1	W2	
Tolerance	Typ	Typ	Typ	Typ	Typ	Typ	Min	Typ	Min	Min	Typ	Max	
VCC1	16	7.5	1.5	4	8	180	2	13	21	60	17	21	1000



**Table 12. Standard Output Frequencies (MHz)**

1.544	1.843	2.000	2.048	2.560	3.080	3.686	4.000	4.032	4.096
4.9152	5.000	6.000	6.176	7.3728	7.680	8.000	8.192	9.216	9.600
9.830	10.000	10.240	10.486	12.000	12.222	12.2725	12.288	12.352	12.500
12.544	12.624	12.729	12.800	12.81089	12.960	13.000	13.070	13.107	13.200
13.248	13.400	13.401	13.500	13.560	13.711	13.824	14.000	14.284	14.2848
14.285	14.318	14.31818	14.336	14.400	14.500	14.5152	14.720	14.736	14.745
14.746	15.000	15.211	15.360	15.555	15.625	15.748	15.74886	15.974	16.000
16.016	16.128	16.368	16.384	16.388	16.500	16.588	16.610	16.660	16.666
16.667	16.670	16.776	16.780	16.896	16.9344	17.000	17.0664	17.37476	17.408
17.600	17.664	17.734	17.73448	17.920	17.992	18.000	18.333	18.400	18.432
18.688	18.750	19.000	19.022	19.200	19.268	19.286	19.392	19.440	19.456
19.530	19.654	19.660	19.6608	19.752	19.774	19.872	19.968	20.000	20.00271
20.141	20.200	20.2752	20.480	20.516	20.712	20.736	20.769	20.7692	20.800
20.828	20.829	20.829	20.830	20.875	20.950	20.971	21.000	21.333	21.400
21.500	21.504	21.616	21.71055	21.711	22.000	22.118	22.174	22.184	22.217
22.500	22.579	22.5792	22.600	22.855	22.85568	23.000	23.040	23.732	24.000
24.431	24.444	24.540	24.545	24.5454	24.576	24.704	24.832	25.000	25.088
25.175	25.180	25.272	25.920	26.000	26.25641	26.664	26.6649	26.666	27.000
27.120	27.500	28.000	28.224	28.60489	28.636	28.63636	28.65645	28.672	28.800
29.000	29.265	29.491	29.49893	29.500	30.000	30.150	30.200	30.720	30.880
31.000	31.104	31.250	31.307	31.500	31.680	31.948	31.949	32.000	32.250
32.256	32.270	32.500	32.764	32.768	32.768	32.800	33.000	33.1776	33.300
33.333	33.792	33.810	33.860	33.8688	34.368	34.450	34.560	34.816	35.000
35.280	35.46895	35.500	35.600	35.840	35.984	36.000	36.500	36.666	36.860
36.864	36.923	37.000	37.056	37.140	37.376	37.500	37.643	38.000	38.3107
38.800	38.810	38.880	38.912	39.0625	39.497	39.9278	40.000	40.010	40.079
40.500	40.550	40.632	40.63232	40.920	40.960	41.472	41.500	41.657	41.660
41.670	41.750	41.895	41.931	42.000	42.400	42.500	42.620	43.000	43.560
44.000	44.137	44.236	44.250	44.267	44.330	44.434	44.539	44.732	44.736
44.928	45.000	45.135	45.158	45.818	46.080	46.232	46.2321	46.320	46.796
46.864	47.13333	47.16602	47.197	47.404	47.40437	48.000	48.33008	48.587	48.58736
48.600	48.81441	49.127	49.152	49.36221	49.408	49.512	49.58632	49.867	49.980
50.000	51.156	51.200	51.840	51.840	52.000	52.416	52.500	52.560	53.125
53.330	54.000	54.072	54.125	54.2174	54.500	55.000	55.289	55.500	56.000
56.064	56.446	56.448	56.666	57.272	57.344	57.600	57.800	58.000	58.250
58.320	58.982	58.982	59.000	60.000	60.480	61.000	61.250	61.440	62.000
62.208	62.500	62.800	63.000	63.8976	64.000	64.512	65.000	65.520	65.536
66.000	66.600	66.660	66.666	66.667	66.670	67.500	67.584	68.000	68.680
68.736	69.632	70.000	70.626	70.656	70.660	70.676	70.833	71.680	72.000
73.728	74.176	74.250	75.000	76.800	77.680	77.760	78.000	78.336	79.452
80.000	81.000	81.920	83.000	83.300	83.333	85.000	87.040	87.182	87.472
89.472	89.512	89.97804	90.000	91.008	92.000	95.000	96.000	97.776	98.304
100.000	102.400	103.680	104.000	106.250	110.000	112.500	114.000	115.200	116.640
120.000	125.000	125.010	127.000	128.000	133.000	135.000	144.600	150.000	155.520
156.250	157.000	166.000	167.000	189.000	190.000				

## Ordering Information

### VCC1- B3B- xxMxxxxxxxXX

**Product**

7x5 Crystal Oscillator

**Power Supply**

- A: +5.0 Vdc, 15pF
- B: +3.3 Vdc, 15pF
- C: +3.0 Vdc, 15pF
- E: +5.0 Vdc, 50pF
- F: +3.3 Vdc, 50pF
- G: +2.5 Vdc, 15pF
- H: +1.8 Vdc, 15pF

**Electrical Options:**

**3: Tri-state 45/55% Duty Cycle**

*The following codes are not recommended for new designs*

- 0: No Tri-state, 40/60% Duty
- 1: Tri-state, 40/60% Duty
- 2: No tri-state, 45/55% Duty
- 5: Enable, 40/60% Duty
- 6: Enable, 45/55% Duty

**Packaging**

- TR: Tape and Reel
- blank: Cut Tape / non Tape and Reel quantities
- \_SNPB: Tin lead solder dipped

Frequency in MHz

**Stability**

- A: ±100ppm over -10/70°C
- B: ±50ppm over -10/70°C
- C: ±100ppm over -40/85°C
- D: ±50ppm over -40/85°C
- E: ±25ppm over -10/70°C
- F: ±25ppm over -40/85°C
- K: ±32ppm over -10/70°C
- O: ±32ppm over -40/85°C
- P: ±100ppm over -55/125°C
- R: ±50ppm over -55/125°C

\*Note: not all combination of options are available.  
Other specifications may be available upon request.

**Example:**

<b>VCC1-B3D-125M000000TR</b>	<b>Tape and Reel</b>
<b>VCC1-B3D-125M0000000</b>	<b>Cut Tape</b>
<b>VCC1-B3D-125M0000000_SNPB</b>	<b>Tin lead solder dipped</b>

## 20ppm Stability Ordering Information

- VCC1-105-frequency = ±20ppm over -10/70°C, +5.0Vdc, 45/55% Duty Cycle, 15pF load
- VCC1-103-frequency = ±20ppm over -10/70°C, +3.3Vdc, 45/55% Duty Cycle, 15pF load
- VCC1-118-frequency = ±20ppm over -10/70°C, +2.5Vdc, 45/55% Duty Cycle, 15pF load
- VCC1-119-frequency = ±20ppm over -10/70°C, +1.8Vdc, 45/55% Duty Cycle, 15pF load

**Example:**

<b>VCC1-105-19M4400000TR</b>	<b>Tape and Reel</b>
<b>VCC1-105-19M4400000</b>	<b>Cut Tape</b>
<b>VCC1-105-19M4400000_SNPB</b>	<b>Tin lead solder dipped</b>

## Revision History

Revision Date	Approved	Description
August 10, 2018	FB	Update logo and contact information, add SNPB-DIP ordering option
August 08, 2019	FB	Update logo and contact information, change to SNPB ordering
April 30, 2020	FB	Add tape and reel ordering option

## Contact Information

### **USA:**

100 Watts Street  
Mt Holly Springs, PA 17065  
Tel: 1.717.486.3411  
Fax: 1.717.486.5920

### **Europe:**

Landstrasse  
74924 Neckarbischofsheim  
Germany  
Tel: +49 (0) 7268.801.0  
Fax: +49 (0) 7268.801.281



Information contained in this publication regarding device applications and the like is provided only for your convenience and may be superseded by updates. It is your responsibility to ensure that your application meets with your specifications. MICROCHIP MAKES NO REPRESENTATION OR WARRANTIES OF ANY KIND WHETHER EXPRESS OR IMPLIED, WRITTEN OR ORAL, STATUTORY OR OTHERWISE, RELATED TO THE INFORMATION INCLUDING, BUT NOT LIMITED TO ITS CONDITION, QUALITY, PERFORMANCE, MERCHANTABILITY OR FITNESS FOR PURPOSE. Microchip disclaims all liability arising from this information and its use. Use of Microchip devices in life support and/or safety applications is entirely at the buyer's risk, and the buyer agrees to defend, indemnify and hold harmless Microchip from any and all damages, claims, suits, or expenses resulting from such use. No licenses are conveyed, implicitly, or otherwise, under any Microchip intellectual property rights unless otherwise stated.

### **Trademarks**

The Microchip and Vectron names and logos are registered trademarks of Microchip Technology Incorporated in the U.S.A. and other countries.