

# CGA5C2C0G1H223J060AD

TDK Item Description : CGA5C2C0G1H223JT\*\*\*B



Equivalent C3216C0G1H223J for Automotive

## Application & Main Feature

Automotive Grade ( Conductive Epoxy Application )

## Series

CGA5(3216) [EIA 1206]

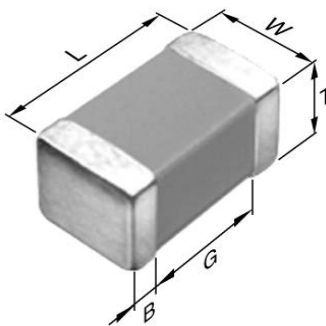

## Dimensions

L	3.20mm +0.3,-0.1mm
W	1.60mm +0.3,-0.1mm
T	0.60mm ±0.15mm
B	0.20mm Min.
G	1.00mm Min.

## Temperature Characteristic

C0G (-55 to 125 degC 0+/-30ppm/degC)

## Rated Voltage

1H(50Vdc)

## Capacitance

22nF

## Capacitance Tolerance

J (±5%)

## Q Factor

1000 Min.

## Insulation Resistance

10Gohm Min

## AEC-Q200

Yes

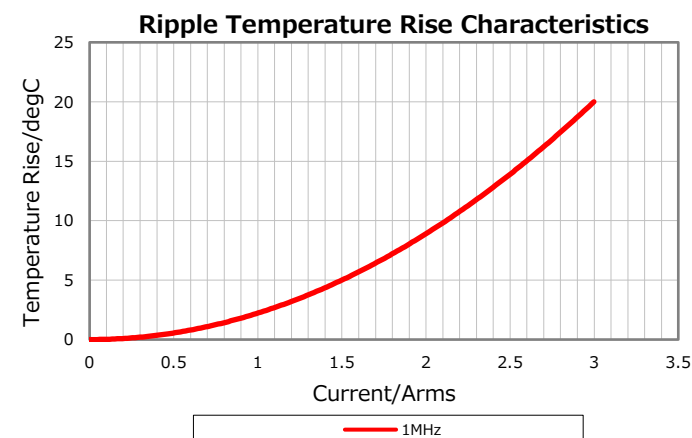
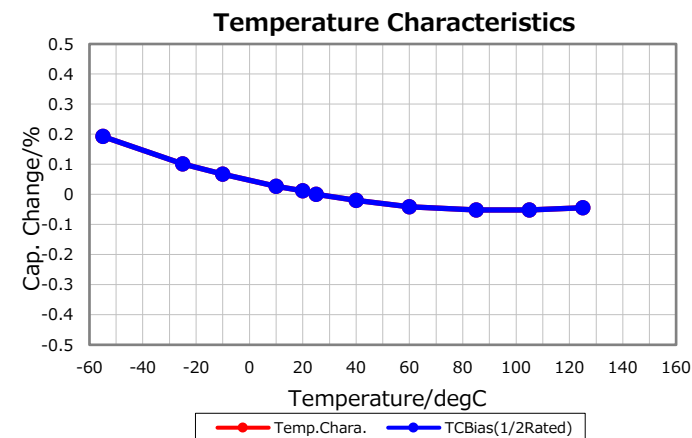
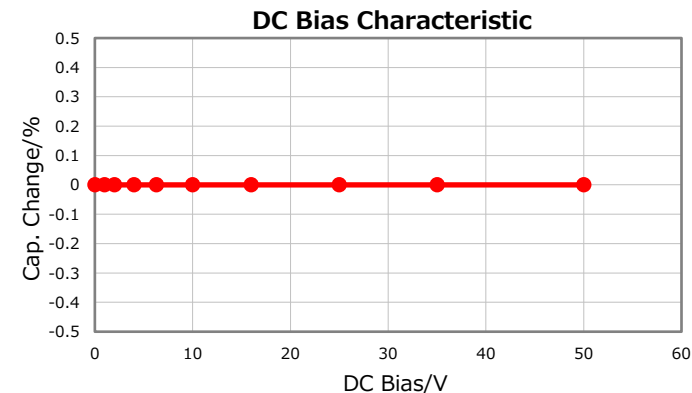
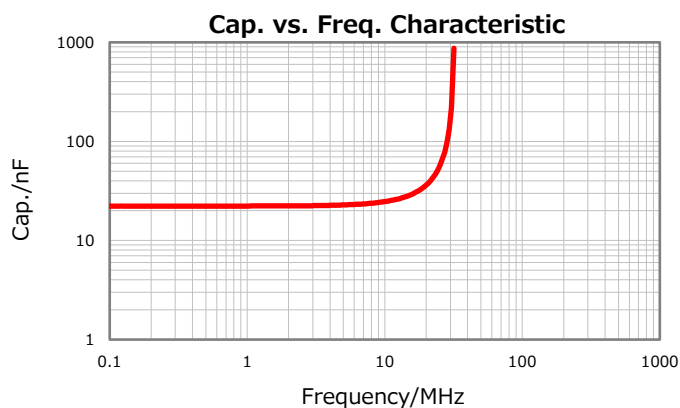
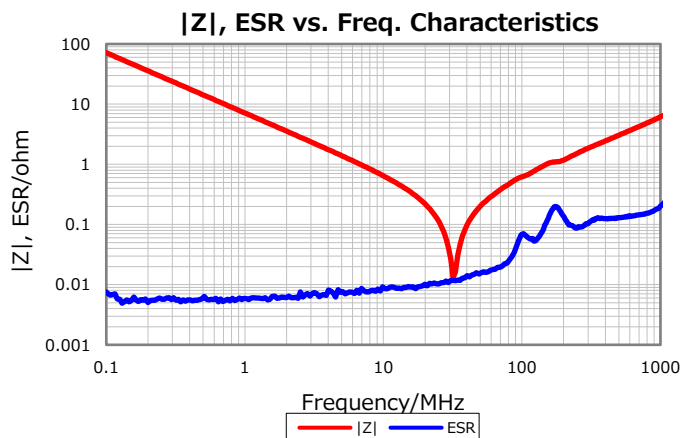

Characterization Sheet ( Multilayer Ceramic Chip Capacitors )



All specifications are subject to change without notice.

May 22, 2019