



life.augmented

Automotive Solutions for Body and Convenience



Contents

- 4 Smart Mobility**
- 5 Body and Convenience**
- 6 Key applications**
 - 7 Body Control Module (BCM)
 - 8 Car Exterior Lighting
 - 9 LED Lighting System
 - 10 Door Control Module
 - 11 Door Lock
 - 12 HVAC and Climate Control
 - 13 Seat Control Module
 - 14 Automotive Gateway
 - 15 NFC Keyless Entry
 - 16 Trunk Control System
 - 17 Power Distribution
 - 18 Heating System
 - 19 Dome Module
 - 20 Head-Up Display (HUD)
 - 21 USB Type-C Power Delivery
- 22 Key Technologies**
- 24 Development Tools**

Smart Mobility

It is estimated that 80% of all innovations in the automotive industry today are directly or indirectly enabled by electronics.

With vehicle functionality improving with every new model this means a continuous increase in the semiconductor content per car.

With over 30 years' experience in automotive electronics, ST is a solid, innovative, and reliable partner with whom to build the future of transportation.

ST's Smart Mobility products and solutions are making driving safer, greener and more connected through the combination of several of our technologies.

80%

of all innovations in the automotive industry today are enabled by electronics



SAFER

Driving is safer thanks to our Advanced Driver Assistance Systems (ADAS) products – vision processing, radar, imaging and sensors, as well as our adaptive lighting systems, user display and monitoring technologies.

GREENER

Driving is greener with our automotive processors for engine management units, engine management systems, high-efficiency smart power electronics at the heart of all automotive sub-systems and silicon-carbide (SiC) devices for hybrid and electric vehicle applications.

MORE CONNECTED

And vehicles are more connected using our infotainment-system and telematics processors and sensors, as well as our radio tuners and amplifiers, positioning technologies, and secure car-to-car and car-to-infrastructure (V2X) connectivity solutions.

ST supports a wide range of automotive applications, from Powertrain for ICE, Chassis and Safety, Body and Convenience to Telematics and Infotainment, paving the way to the new era of car electrification, advanced driving systems and secure car connectivity.

Body and Convenience



Car body and convenience applications are evolving to increase the comfort of both drivers and passengers. Vehicle manufacturers need solutions that have the flexibility to cover a wide range of car models and a broad range of options. These solutions need to communicate increasing amounts of data to enable decentralized control, enhanced functional safety levels, as well as efficient diagnostic and maintenance capabilities.

Body control modules (BCM) are increasingly being used to control multiple vehicle functions, with integration becoming a key discriminator. Cost-effective flexible semiconductor solutions for BCMs depend upon having the right technology for the application needs.

ST has the broadest product portfolio dedicated to body and convenience solutions, covering interior and exterior lighting systems for bulbs, xenon HID and LEDs and drive controllers for stepper, brushed and brushless DC motors. We provide complete solutions for seat positioning and trunk, mirror, window, wiper and lock control as well as everything required for automatic climate control systems. In addition, we supply connectivity solutions to link all the sub-systems together, whether with LIN, CAN or Ethernet.

Our proven automotive-grade Smart Power technologies, Bipolar-CMOS-DMOS (BCD) and VIPower™ can combine multiple functions on a single chip to provide unprecedented levels of integration. Our CMOS and discrete power technologies complement the Smart Power technologies and our wide range of automotive packages completes the offer.

Key Applications

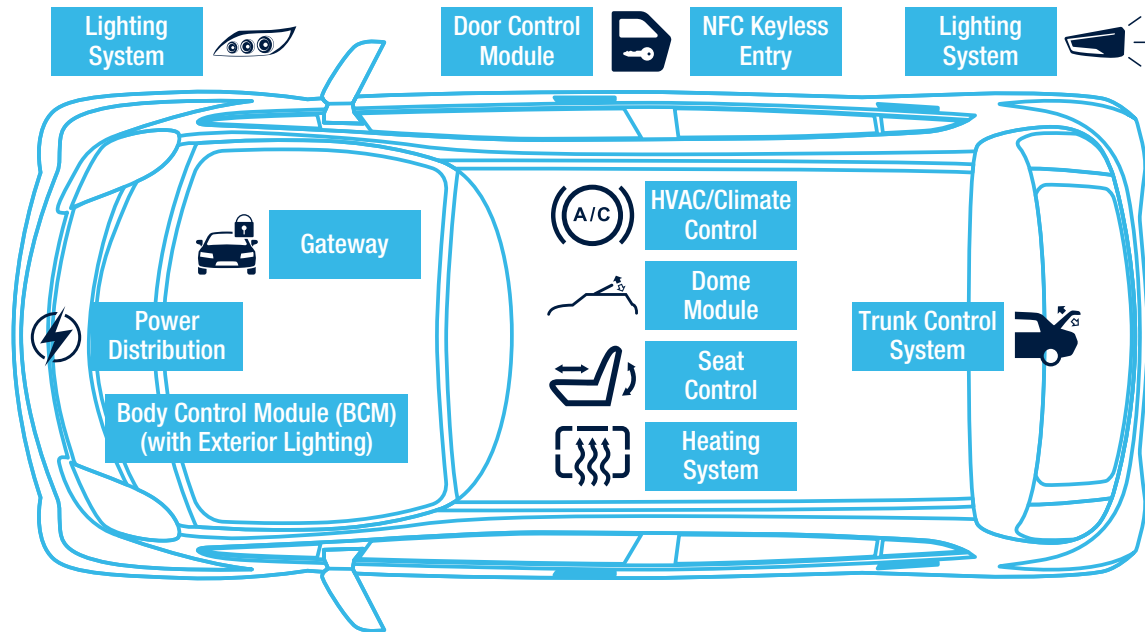

SOLUTIONS

ST's key products and solutions for body and convenience applications include:

VIpower™ and BCD Actuators, Motor Control and LED drivers	Sensors	EEPROM	Power Management	EOS and ESD Protection	32-bit Automotive Microcontrollers
	NFC	Connectivity	Power Diode, MOSFET & IGBT	Dedicated Door Module ICs	

HW & SW Development Tools – Sample Kits, Evaluation Kits, Product Selectors



FIND OUT MORE

www.st.com/body-and-convenience

Body Control Module
USB Type-C Power Delivery
Dome Module
Door Lock
Door Module

Exterior Lighting
Gateway
Head-up Display
Heating System
HVAC / Climate Control

LED Lighting System
NFC Keyless entry
Power Distribution
Seat Control
Trunk Control System

BODY CONTROL MODULE (BCM)

Body control modules add increased safety, security and convenience functionality to vehicles. These modules monitor and control the functions adding to their overall reliability and efficiency. As automobiles become increasingly complex, and increasingly reliant on networked systems, BCMs are becoming a key factor in vehicle design. Many vehicles now employ multiple BCMs, each dedicated to a specific subsystem, such as:

- Lighting control including incandescent, HID, Xenon, and LED lamps as well as their related diagnostics monitoring (overload and temperature protection, bulb outage detection, etc);
- Motor control drives for mirrors, wipers, windows, seat position, dome, door & safe lock, and washer pumps;
- Security control for immobilizers and NFC keyless entry systems.

BCM's are at the forefront of the trend to replace the traditional relay-based systems with integrated power devices with embedded diagnostics. Cost-effective flexible semiconductor solutions for BCMs depend upon having the right technology for the application needs.

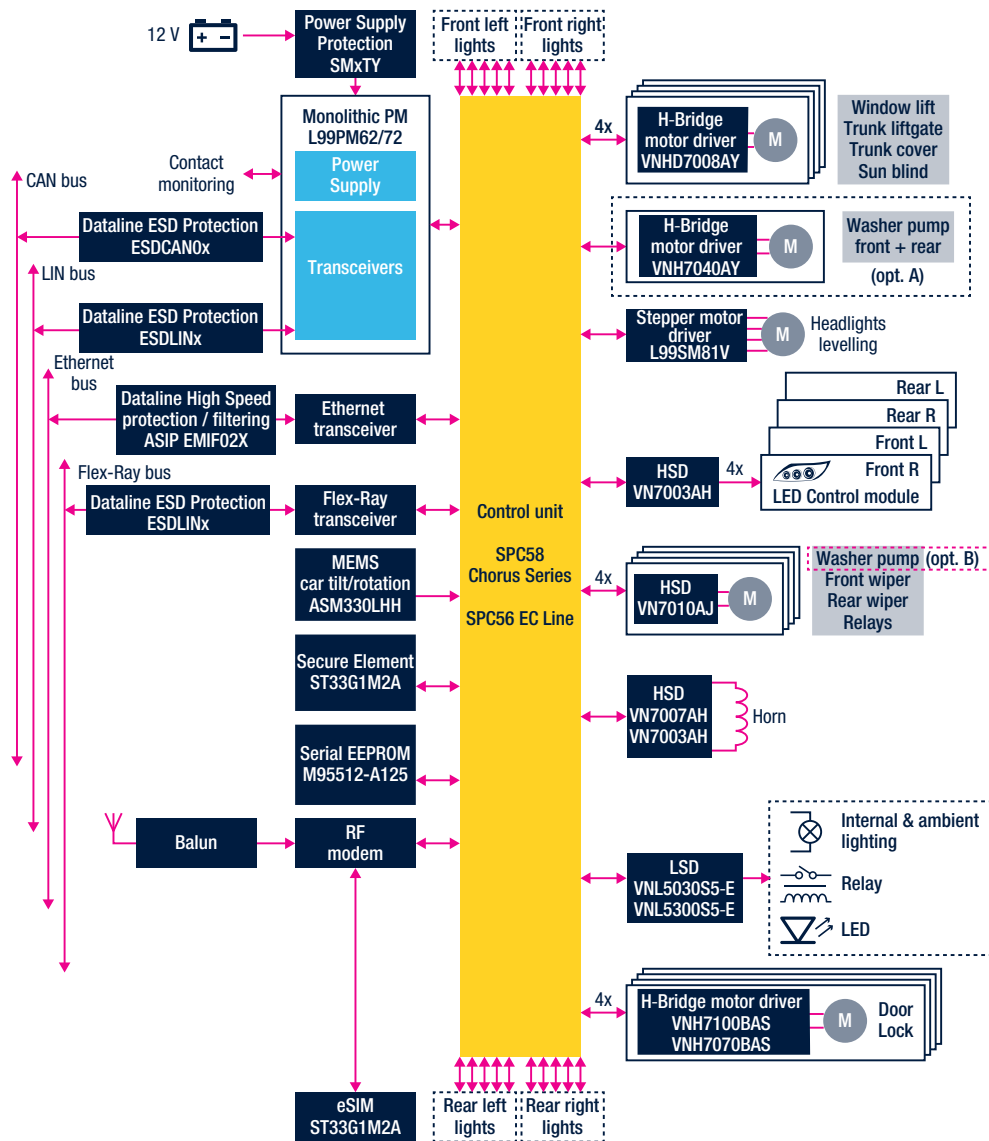

FIND OUT MORE
www.st.com/body-control-module

Visit our BCM solutions page featuring our VIpower high-side drivers and related Easy Boards addressing several automotive applications

CAR EXTERIOR LIGHTING

Traditional incandescent lighting systems have not yet totally been replaced by LEDs. The requirements for reliability remain as lighting is key to driver and pedestrian safety. ST supplies solutions for vehicle headlights, taillights and indicators/flashers offering a wide selection of high- and low-side drivers. These can drive a range of wattage requirements from high-power “high beam” lamps, through front or rear lights and down to low-power loads such as indicators and back lights.



FIND OUT MORE

www.st.com/car-exterior-lighting

Visit our Car Exterior Lighting Resource page for a list of selection guides and application notes with helpful guidelines for improving the efficiency and performance of your designs

LED LIGHTING SYSTEM

In all automotive lighting systems, LEDs are replacing existing technologies due to their inherent power efficiency, increased lifetime (with innate shock resistance), design flexibility and continuing cost reduction.

LEDs are transforming the external design of vehicles with new styles and forms of lighting adding to the personality of every new vehicle. Today's smart lighting systems require sophisticated LED drive solutions that include advanced diagnostics (LED string disconnection detection, overload, etc.) and control features (PWM, DC). In addition, more advanced systems implement dynamic lighting and motor drives for headlamp levelling and beam control.

ST has a complete range of solutions for lighting needs, from analog drivers and advanced regulators to dedicated highly flexible drivers for full LED lighting. High-performance, cost-effective automotive microcontrollers and an extensive standard product portfolio complete the offer.

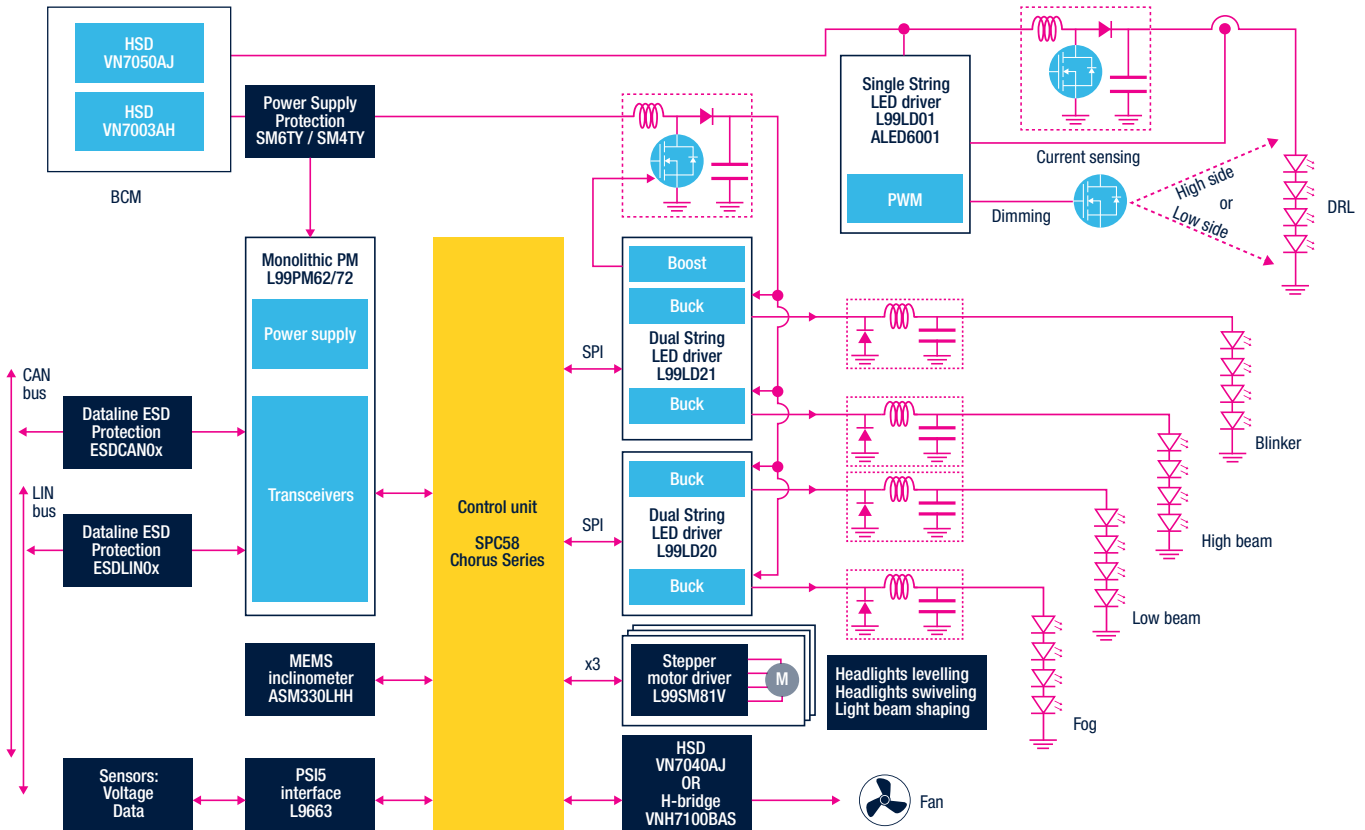

FIND OUT MORE
www.st.com/led-front-light

Discover our adaptive front lighting kit built around ST's AutoDevKit™ development initiative, a viable, simple, low-cost and time-optimized tool for automotive application engineers

DOOR CONTROL MODULE

Decentralized architecture

Door modules, in their simplest form, need to be able to reliably control standard loads such as those presented by door locking motors. In more complex door zone systems, the chipset needs to not only control multiple standard loads such as door lock motors, mirror folders and levellers, but also those for defrosters and several lighting functions from LEDs to incandescent bulbs. Solutions need to be both flexible and scalable, to satisfy the need for different door electronic variants from basic to premium. ST offers “Door Zone System ICs” integrating a power management block, CAN and LIN transceivers and drivers/actuators for additional loads, all in one single package. Other solutions are also available, such as an integrated two-chip solution tailored for different door variants, a range of 5V regulators with varying current loads, and high- and low-side drivers in VIPower™ technology.

ESD and battery protection devices complement the offer to cover all design requirements.

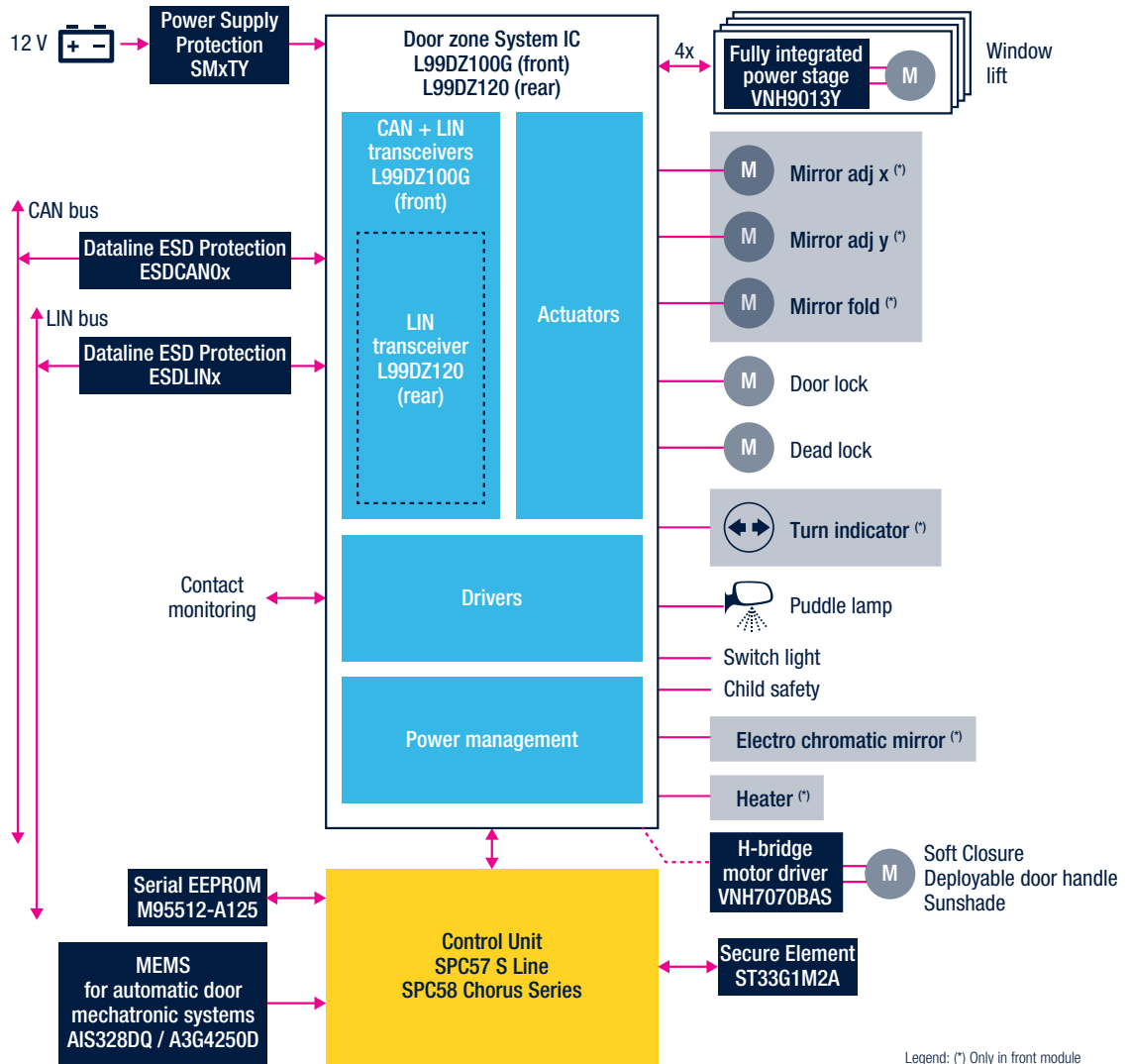

FIND OUT MORE

www.st.com/door-control-module

Discover our range of door zone system IC providing electronic control modules with enhanced power management power supply functionality, including various standby modes, as well as LIN and HS CAN physical communication layers. A complete set of evaluation boards is available with a user-friendly GUI that lets developers set device parameters and at the same time it shows real-time device diagnostic information as the current output evolution, the battery voltage monitoring, the board temperature and much more.



DOOR LOCK

Centralized architecture

Most vehicles today employ a body control module (BCM) or a dedicated ECU to control door locking and unlocking. Originally employed in luxury cars, electronic control of vehicle access has become almost universal. The systems have now evolved adding trunk and fuel lid locking to control of the four doors.

ST offers an innovative integrated door lock IC (L99UDL01) that embeds actuation and driving functions, specifically designed to be flexible enough to drive most of the existing car door lock configurations including management of trunks, fuel lids or EV plug lids. Furthermore, the addition of a secure element (MCU) guarantees a high level of security against malicious intrusion attempts.

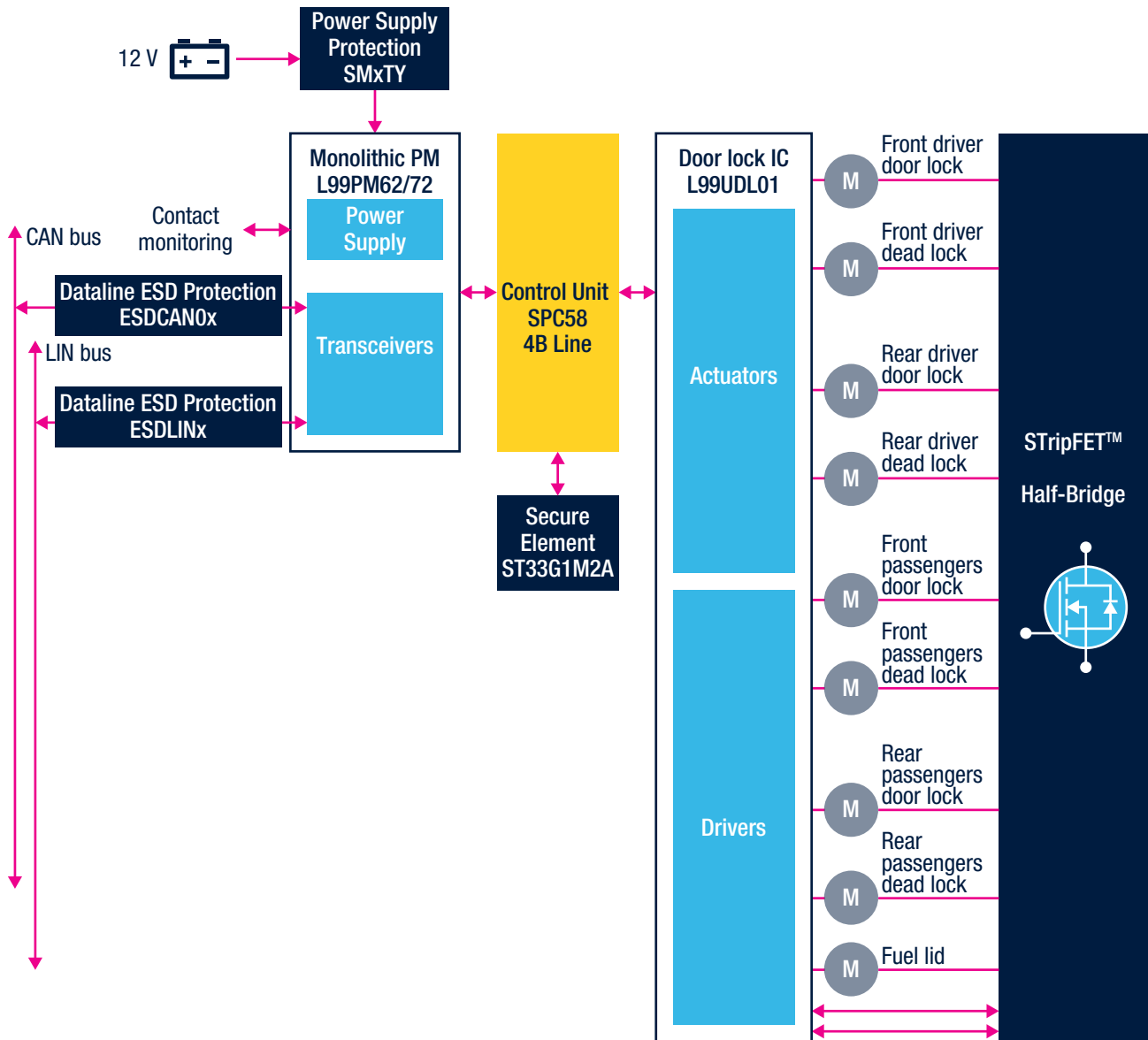

FIND OUT MORE

www.st.com/door-lock

Designed to demonstrate the centralized control of all the locks available in a vehicle, our L99UDL01 Evaluation board comes with a user-friendly software GUI that lets developers set the L99UDL01 control parameters and at the same time shows real time diagnostics information as current output and battery voltage monitoring.



HVAC AND CLIMATE CONTROL

Heating Ventilation and Air Conditioning (HVAC) systems provide an essential level of cabin comfort. ST provides hardware and software solutions for a wide variety of HVAC implementations: microcontrollers, high- and low-side drivers, stepper motors drivers for flaps and DC / BLDC blower fan motors are all available to enable a reliable cabin climate control system. ST's environmental sensors and interfacing ICs close the feedback loop.

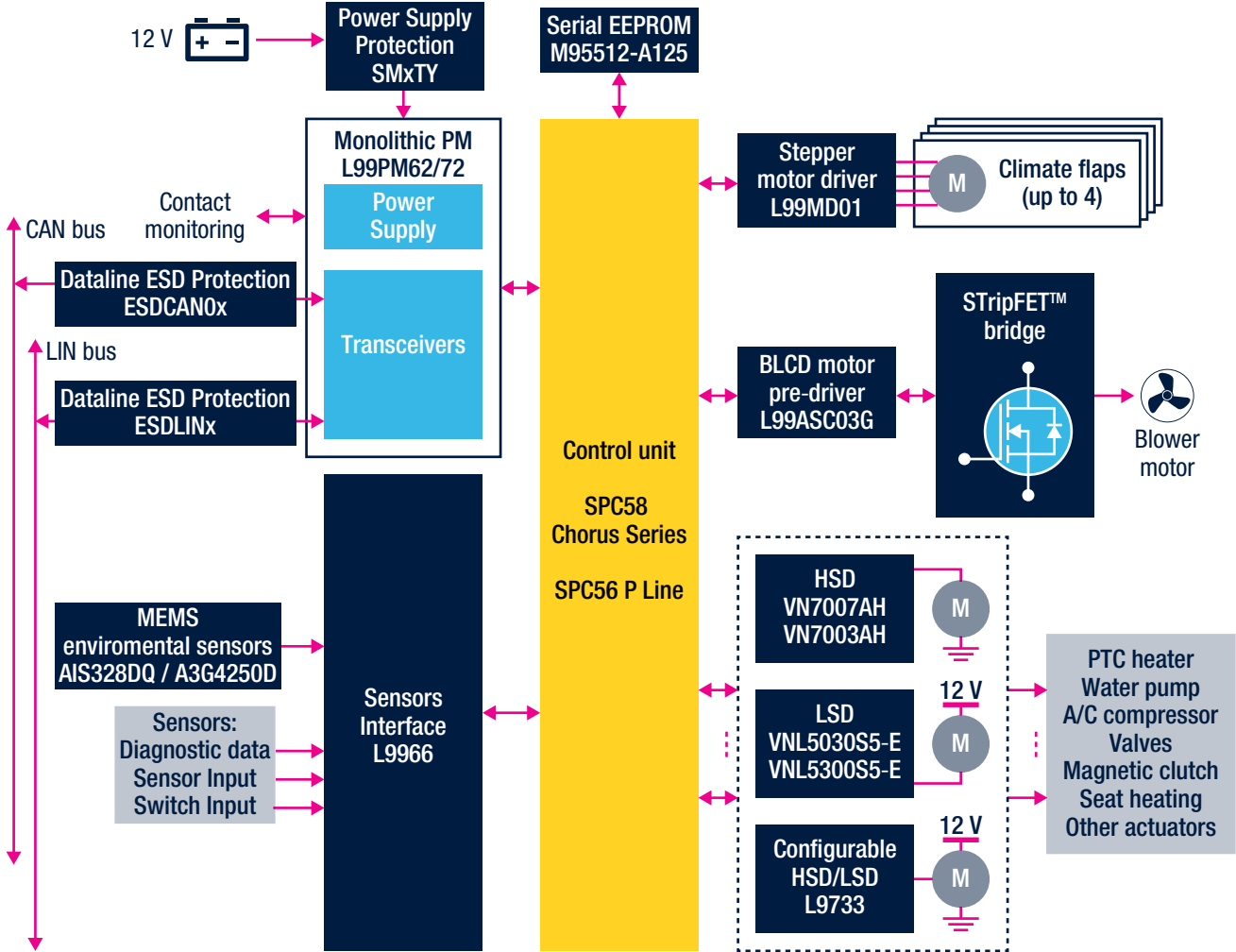

FIND OUT MORE

www.st.com/hvac-and-climate-control

Discover our wide range of evaluation boards for SPC5 automotive microcontrollers, VIPower low-voltage power MOSFETs, sensorless 3-phase BLDC motor control, and protection ICs that help developers find the best solution for their HVAC and Climate Control application.

SEAT CONTROL MODULE

Even car seating cannot escape innovation, with car manufacturers bringing fashioned textures, materials and leathers but also new seat features to enhance driving comfort. STMicroelectronics's rich portfolio includes all the necessary components required for innovative automotive seat solutions:

- High-side switches: an unrivalled family of high-side switches, the M0-7 HSDs series, based on proprietary VIPower™ technology
- Motor drivers: the latest generation of H-bridges provide a comprehensive, fully integrated and protected solution for low- and medium-power DC motor applications. Together with our motor drivers in BCD technology, our VIPower™ H-bridges offer an ideal solution to drive seat-positioning motors.
- Power Management: In addition to communication transceivers, our System Basis Chip (SBC) devices supply power and drive loads for seat control modules. For more traditional designs, a broad range of automotive-grade linear voltage regulators is also available.
- Microcontrollers: SPC5 32-bit MCUs for automotive body applications
- Connectivity: Bluetooth, Bluetooth Low Energy and NFC communication modules enable seating adjustment via smartphones.

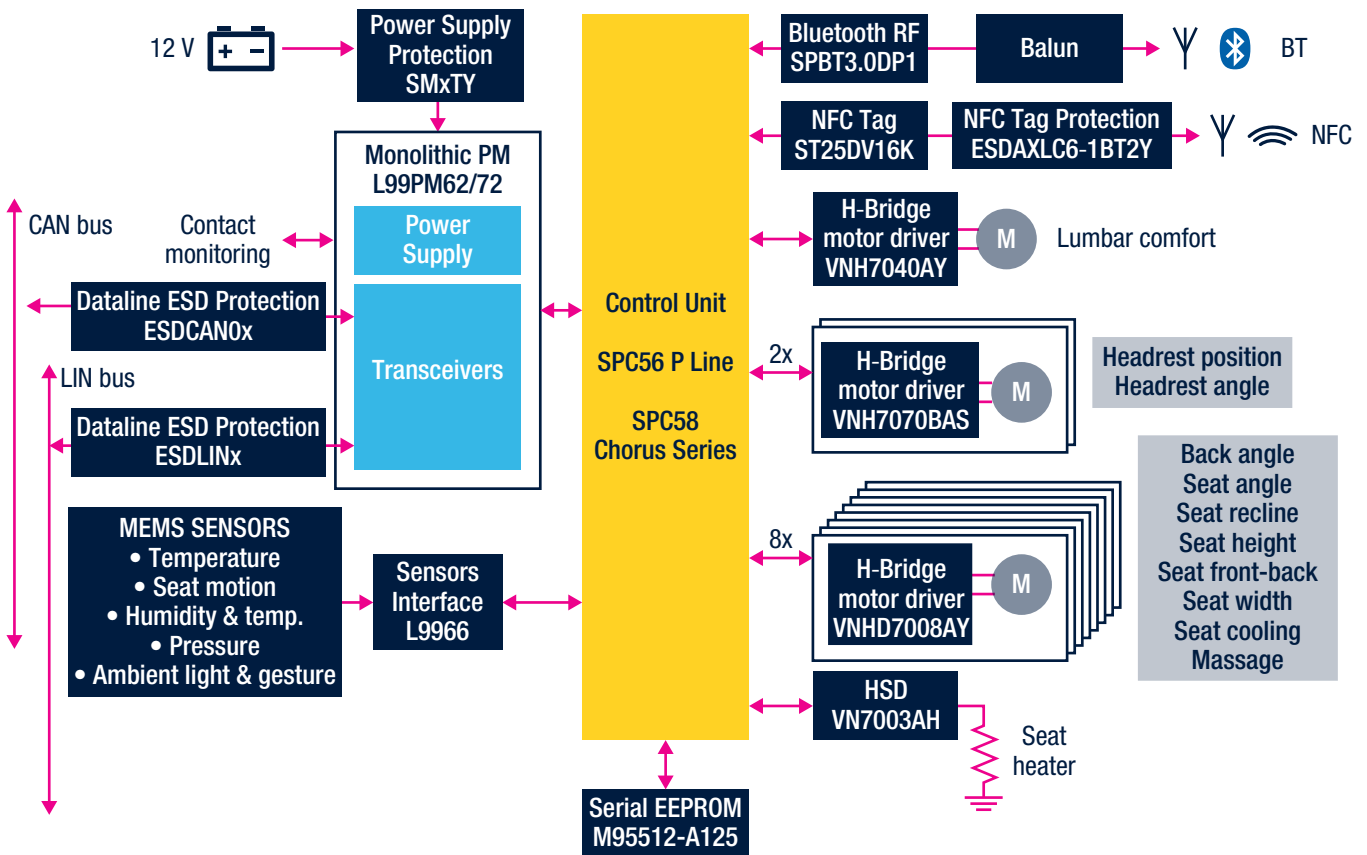

FIND OUT MORE
www.st.com/seat-control

Visit our Seat Control solutions page featuring a selection of VIPower high-side drivers and related Easy Boards addressing dedicated applications. A user-friendly GUI that lets developers set device parameters, monitor real-time device diagnostics and more is also available.

AUTOMOTIVE GATEWAY

The gateway controller plays a fundamental role as a communication bridge between the various networks inside the vehicle and those external to the vehicle, managing the communication interface. Vehicle architectures implement different protocols to allow communication between the various module typologies operating in a vehicle, including CAN (low- and high-speed), LIN, ISO-9141, Flex-Ray, and Ethernet. Security is a key element in vehicle networking and the gateway has a major role in ensuring that the communication networks are not compromised.

The combination of powerful automotive-grade microcontrollers with built-in hardware security modules and secure elements provide a comprehensive gateway security solution.

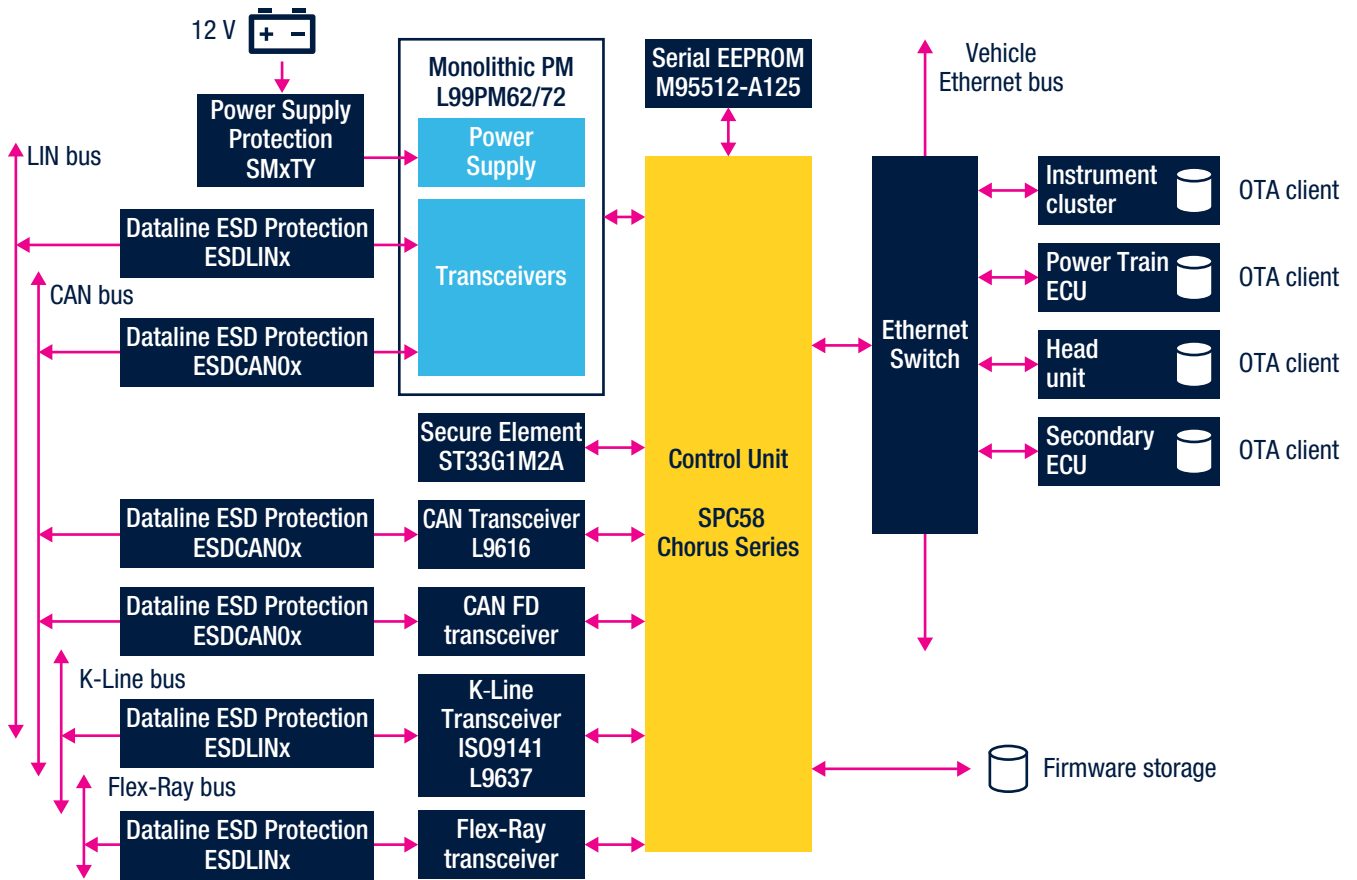

FIND OUT MORE
www.st.com/automotive-gateway

Featuring a rich set of in-vehicle network interfaces, our Smart Gateway Platform evaluation kit provides an easy-to-use development and prototyping platform for advanced automotive gateway and domain controller applications. Comes with a comprehensive Starter Package.

NFC KEYLESS ENTRY

Near Field Communication (NFC) -enabled cards or smartphones provide a convenient and secure way to access vehicles. Car keys have long been a weak link in vehicle security and will progressively be replaced by this technology as it filters down from premium vehicles to the mainstream. The NFC-based solutions will not only add a more flexible and cost-effective access mechanism, they will also provide new possibilities such as enabling rental car companies to send to a renter's smartphone the ability to unlock and start their rental car using NFC.

ST's NFC transceivers and SPC58 microcontrollers with embedded Hardware Security Modules (HSM), cover the most important requirements for such access control applications: security, reliability, usability and cost efficiency.

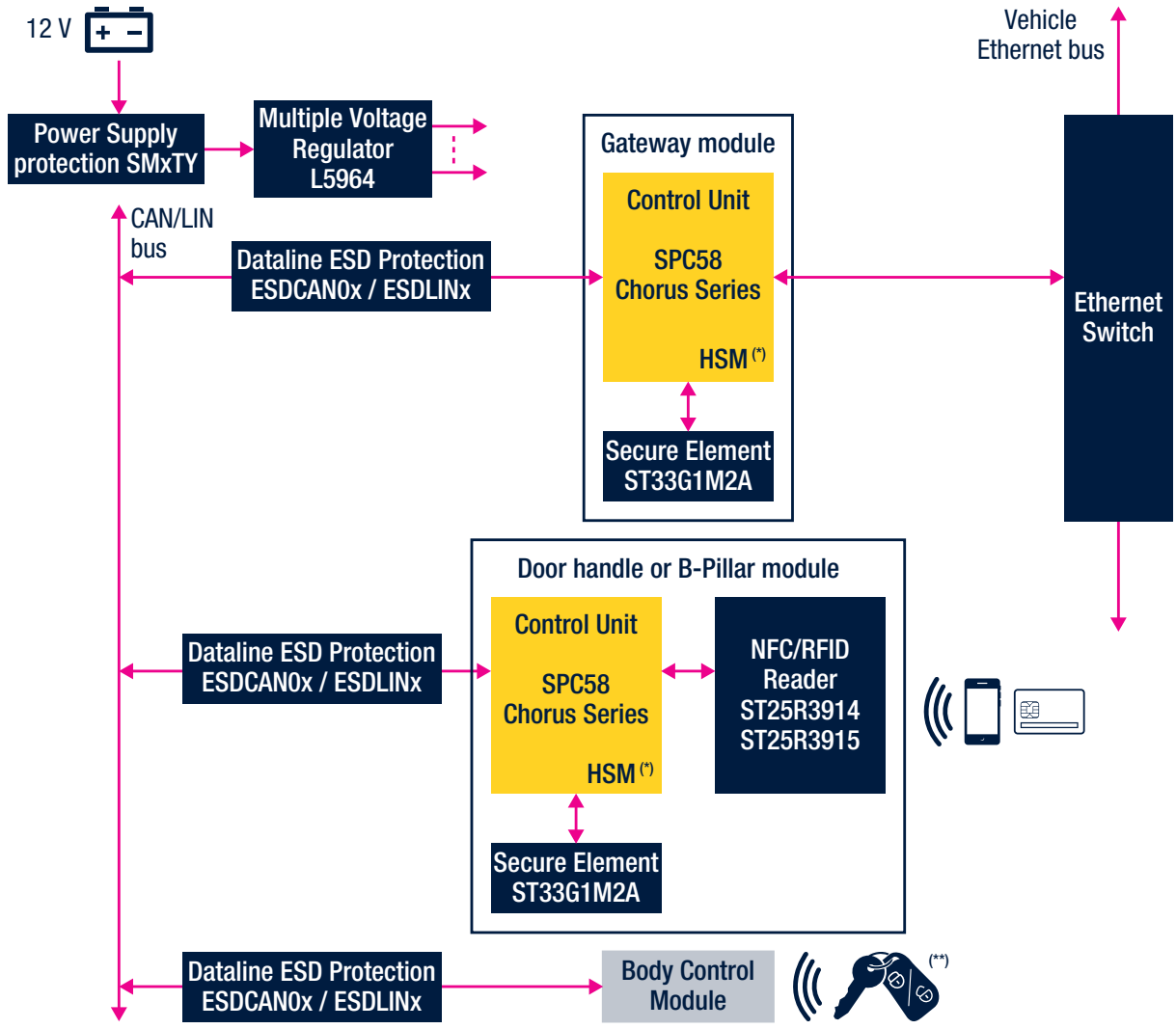

Legend: (*) Hardware Security Module, (**) Accelerometer AIS2DW12 available for PKE keys



FIND OUT MORE
www.st.com/nfc-keyless-entry

Discover our wide range of evaluation boards for NFC Keyless Entry systems including ST25 NFC readers, SPC5 automotive microcontrollers, and protection ICs that help developers find the best solution for their application.

TRUNK CONTROL SYSTEM

ST has a wide range of automotive products that provide complete trunk control solutions with a range of functions. Electronic locking systems require either electric or hydraulic actuators to engage and disengage the latch. Cinch motor drivers and latch mechanisms enable soft-opening and closing of doors and also add failsafe security mechanisms. ST's VIPower™ H-Bridge drivers are ideal for controlling the actuators and locking mechanisms, as they are available in many power ranges and have the networked capability, manageable by a dedicated microcontroller.

ST's Discovery ecosystem allows rapid development combining versatile MCUs e.g. the SPC56 B line with a range of VIPower™ easy boards (from 8 to 100 mΩ) that enable the evaluation of a range of motor driver solutions for car body applications including trunk control systems.

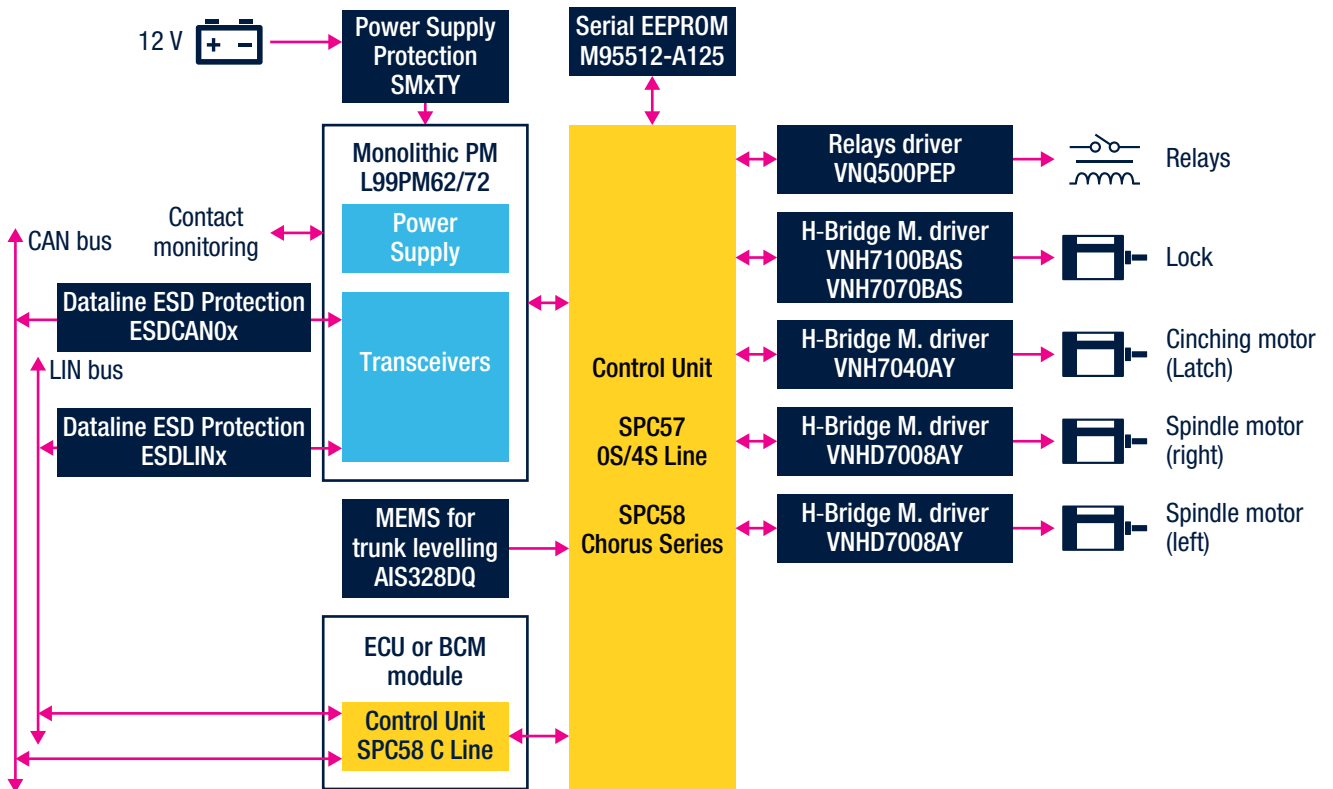

FIND OUT MORE

www.st.com/trunk-control-system

Discover our wide range of evaluation boards for Trunk Control systems including SPC5 automotive microcontrollers, MEMS motion sensors, fully integrated H-bridge motor drivers, and protection ICs that help developers find the best solution for their application.

POWER DISTRIBUTION

The electrification and digitalization of vehicles means that power distribution can no longer rely on a block containing a collection of fuses, relays and circuit-breakers with a multitude of wires. The need for increased efficiency, diagnostics and smarter power distribution has led ST Intelligent Power Switches based on our proprietary VIPower™ technology.

Combined with an automotive grade 32-bit SPC58 MCU, these devices not only provide power and protection for sensitive components such as audio systems they also provide valuable diagnostic and maintenance information, combined with a level of security that protects the power distribution from unwanted interference.

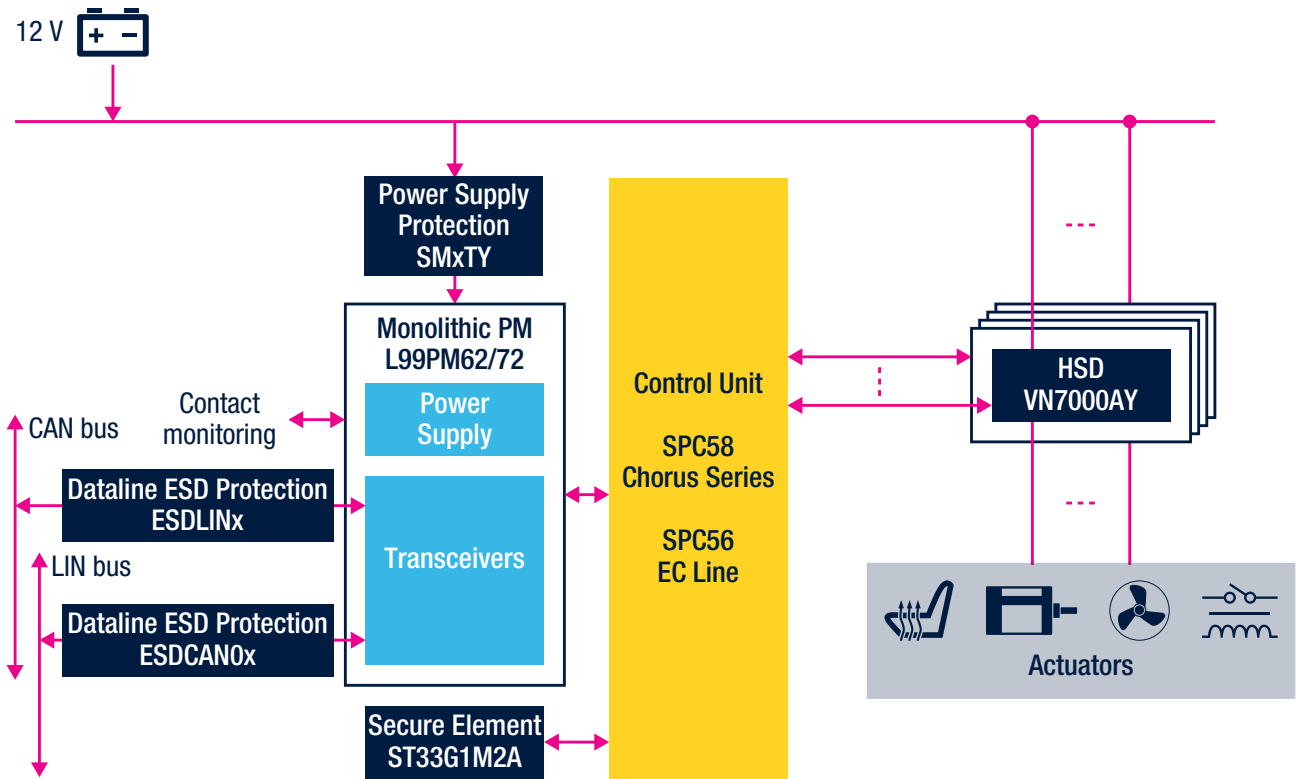

FIND OUT MORE

www.st.com/power-distribution

An easy way to connect our VIPower VN7000AY high-side driver with MultiSense analog feedback into your existing system, our VN7000AY Evaluation Board lets developers directly connect the load, the power supply and the microcontroller without any additional effort in external component design and connection.

HEATING SYSTEM

Heating systems become increasingly complex when all the possible options – seat and cabin heaters, windshield defrost, heated/cooled compartments and glow plug heaters – are considered.

Vehicle manufacturers need a scalable set of solutions to fit the different models in their range, optimized for enhancing comfort for both driver and passengers with accurate and energy-efficient temperature control systems.

We offer a set of VIPower™ Zero series application-specific power ICs and 32-bit SPC5 automotive microcontrollers as well as protection devices to enable the development of scalable car heating systems.

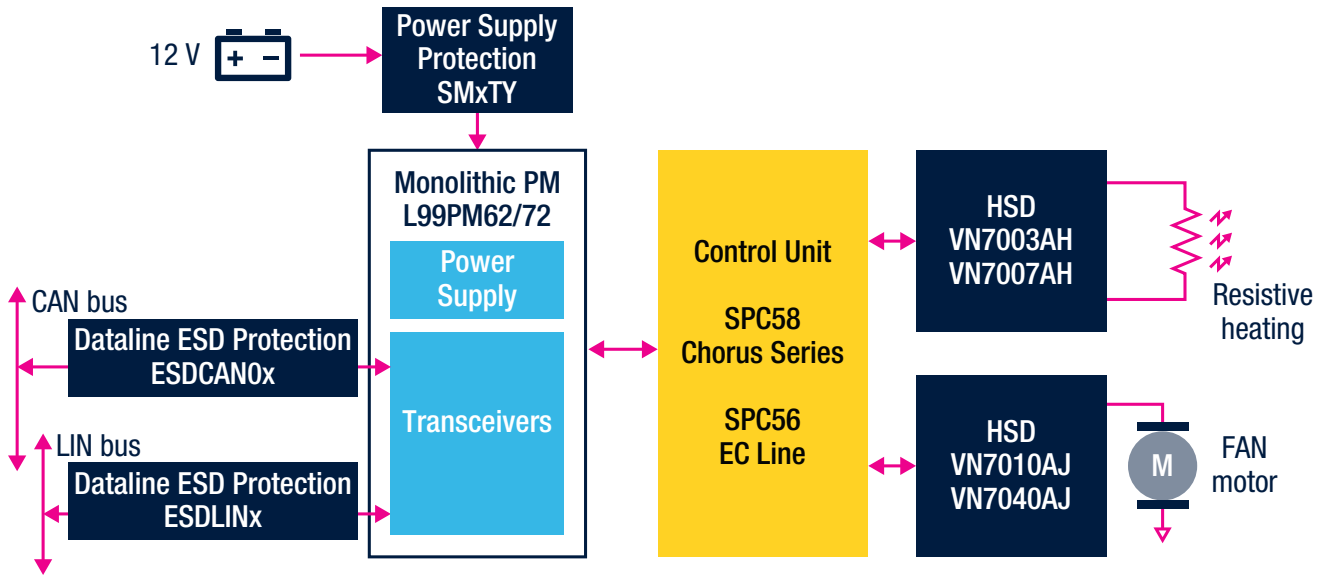

FIND OUT MORE
www.st.com/heating-system

Visit our Heating System solutions page featuring a selection of VIPower high-side drivers and related Easy Boards addressing dedicated applications. A user-friendly GUI that lets developers set device parameters and monitor real-time device diagnostics and more is also available.

DOME MODULE

Dome modules of varying complexity are present in most vehicles; placed in the ceiling of the cockpit they provide lighting and controls that are easily accessible by the driver and passengers. Typical features include:

- Ceiling lighting control for LED light sources
- Sunroof control and security
- Microphones for voice control and hands-free operation
- Ambient light level sensors
- SOS buttons for emergency calls and emergency lighting

ST offers a wide range of MEMS sensors and microphones, leading-edge high- and low-side drivers and motor control functions with fully integrated H-bridges. Protection and networking are also covered with our dataline ESD protection and transceiver ICs.

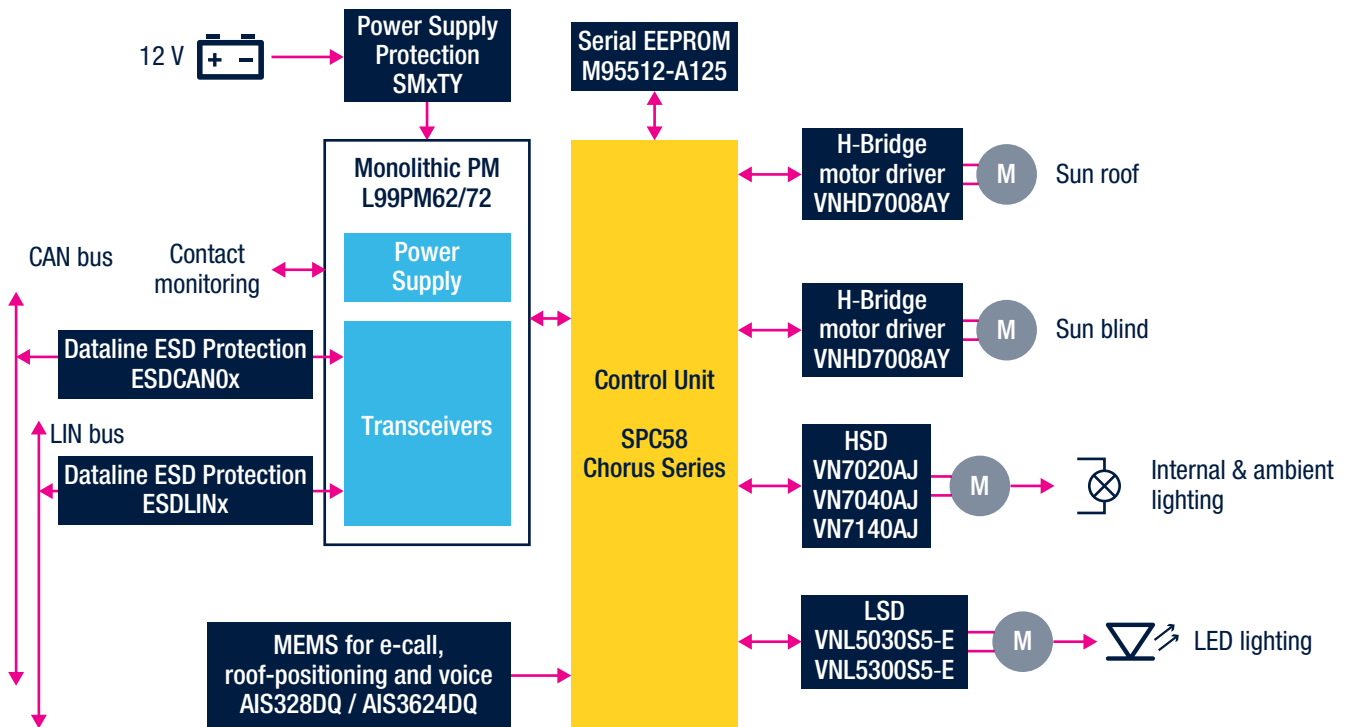

FIND OUT MORE
www.st.com/dome

Visit our Dome Module solutions page featuring a selection of VIPower high-side drivers and related Easy Boards addressing dedicated applications. A user-friendly GUI that lets developers set device parameters and monitor real-time device diagnostics and more is also available.

HEAD-UP DISPLAY (HUD)

The Head-up Display (HUD) reduces dangerous distractions by displaying key information, such as the car's speed, navigation directions and other alerts, directly in the driver's line of sight. First adopted for military purposes on fighter jets, HUD is now playing a crucial role inside the automotive HMI (Human Machine Interface).

A HUD shows the information in the driver's field of view, there is no need to look down at the instrument cluster or the secondary display, and therefore taking their eyes off the road. In the case of a windshield head-up display, drivers are able to see a virtual image as "floating" over the hood at a distance of about 1½ to 2 meters.

ST enables your HUD designs with its programmable stepper motor driver, for image adjustment, monitored by a 32-bit control unit, providing a versatile and cost-effective solution.

Designed to drive one bipolar stepper motor in micro-stepping mode together with coil voltage measurement for stall detection, our L99SM81VY evaluation board comes with a user-friendly software GUI that lets developers set control parameters and monitor real-time information including voltage measurements, main power supply voltage, fault flags, device junction temperature, and more.

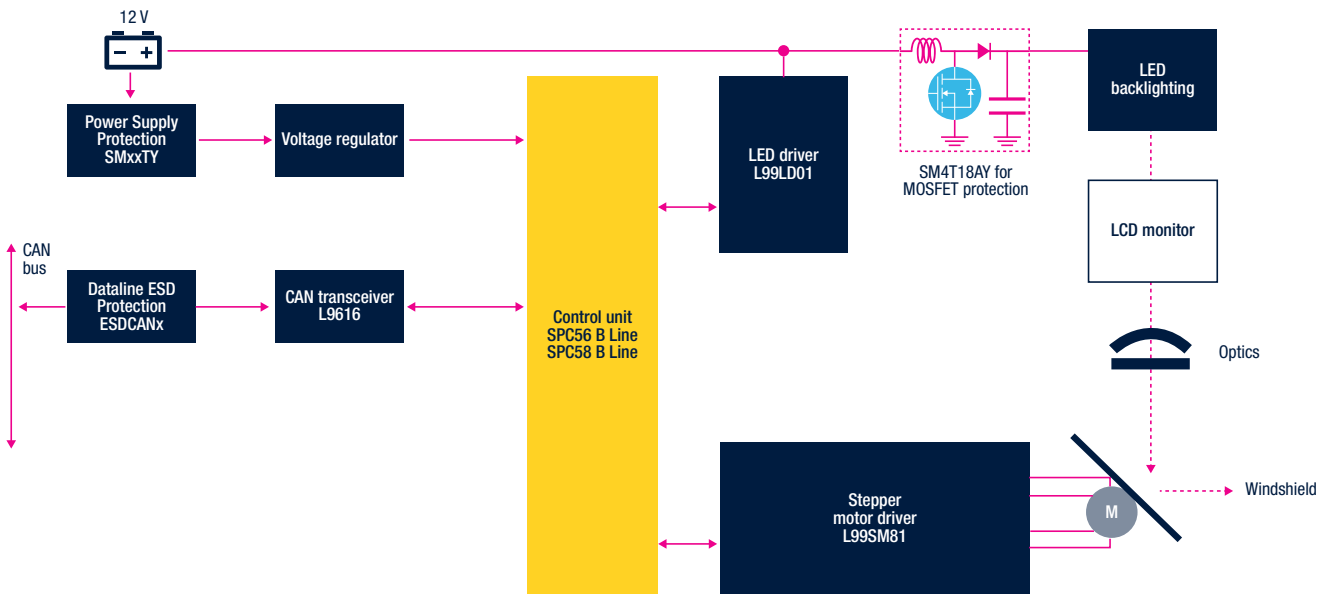

FIND OUT MORE
www.st.com/hud

USB TYPE-C POWER DELIVERY

USB Power Delivery is the next frontier for in-car charging of phones, tablets and mobile PCs: a common cabling for data and power delivery is instrumental to improve re-use and reduce electronic waste; furthermore its cable reversibility significantly enhances the user-experience. The USB Power Delivery protocol enables the connection of different devices with different power profiles: the power negotiation protocol determines the voltage and current profile that the provider supplies to the device.

ST offers a complete dual-port USB Type-C Power Delivery solution kit (SL-PELSTR-B002) for evaluating the USB Power Delivery protocol stack version 2.0, implemented on the ASIL-B automotive grade 32-bit MCU:

- SPC58EC-DISP MCU discovery board with various peripherals (CAN, LIN, Ethernet among others).
- AEK-USB-2TYPEC1 dual port USB Type-C interface board, with a pair of STUSB1702Y automotive grade USB Type-C controllers.
- STSW-USB2TYPEC1 firmware (MCU flash image).
- AEK-POW-L5964V1 power board (sold separately) hosting our PMIC L5964, an automotive grade, dual channel DC-DC buck converter with double channel up to 3A each, single channel up to 5A.

The kit is very flexible, scalable, customizable and automotive grade compliant. For example, through the Microcontroller Discovery board, you can expand your application by connecting additional boards to extend functionalities.

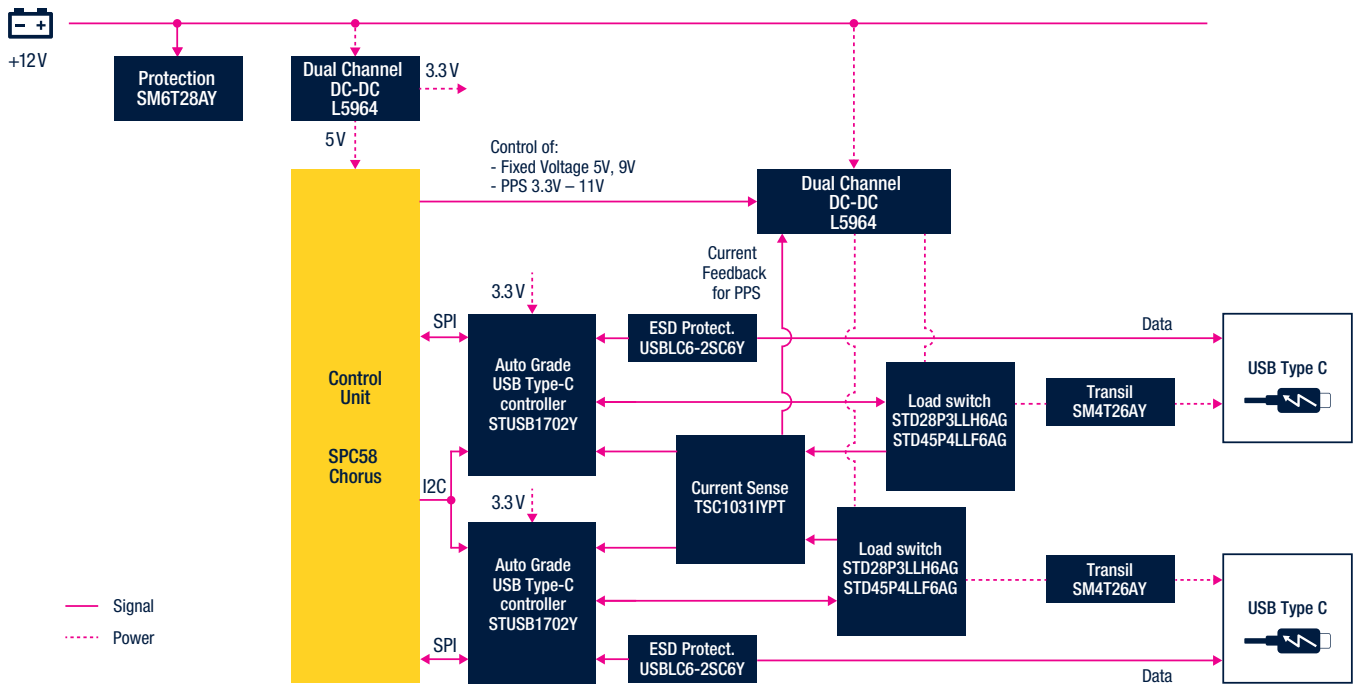

FIND OUT MORE
www.st.com/auto-usb-c

Key Technologies

RESEARCH & DEVELOPMENT AND MANUFACTURING

To keep its technology edge, ST maintains a strong commitment to innovation, with approximately 7,400 people working in R&D and product design and spending about 16% of its revenue in R&D. Among the industry's global technology leaders, ST owns and continuously refreshes a substantial patent library (~17,000 patents; ~9,500 patent families and ~500 new patent filings per year).

The Company draws on a rich pool of chip-manufacturing technologies, including advanced FD-SOI (Fully Depleted Silicon-on-Insulator) CMOS (Complementary Metal Oxide Semiconductor), differentiated Imaging technologies, RF-SOI (RF Silicon-On-Insulator), BiCMOS, BCD (Bipolar, CMOS, DMOS), Silicon Carbide, VIPower™, and MEMS technologies.

ST believes in the benefits of owning manufacturing facilities and operating them in close proximity and coordination with its R&D operations.

ST has a worldwide network of front-end (wafer fabrication) and back-end (assembly, test and packaging) plants. ST's principal wafer fabs are located in Agrate Brianza and Catania (Italy), Crolles, Rousset, and Tours (France), and in Singapore. These are complemented by assembly-and-test facilities located in China, Malaysia, Malta, Morocco, the Philippines, and Singapore.

KEY TECHNOLOGIES FOR AUTOMOTIVE PRODUCTS

Silicon Carbide

Silicon Carbide (SiC) is a wide bandgap material, with many advantages compared to silicon in the field of power electronics. Operating temperatures are higher, heat dissipation is improved and switching and conduction losses are lower making it an ideal technology for vehicle electrification. Silicon Carbide-based traction inverters can increase electric vehicle range and SiC-based chargers reduce the charge time.

ST has been working with Silicon Carbide since 1996. In 2009 ST started to produce its first SiC MOSFETs and since then we have added 1200 V versions of both SiC MOSFETs and power Schottky diodes to complement the original 650 V versions.

ST produces the automotive-grade SiC power devices, in a dedicated 6" front-end wafer fab, that are becoming the key enabler in the automotive industry for vehicle electrification.

VIPower™

VIPower™ is a technology developed by ST and in production since 1991. Vertical Intelligent Power technologies provide control, protection and diagnostics for medium/high power automotive loads. The technology combines Vertical Double Diffused MOS Power devices with their own temperature and current sensors and CMOS and HV components for Power-Analog-Mixed design.

VIPower™ technology is the perfect choice for the control of automotive exterior and interior lighting, DC motors for seat adjustment, door locks and window lifts, resistive heaters and any kind of power load that needs control and sensing as well as power. VIPower™ products are replacing a host of electro-mechanical solutions, and providing lower power, lower chip-count and lower pin-count solutions.

VIPower™ technology will play a key role in the move towards electric vehicles. The smart 48 V networks used in Mild and Full Hybrid cars require intelligent power switches to drive high- and low-sided loads and electric motors, with very low losses and high current sense accuracy, all monitored via the connections to the ECUs microcontroller.

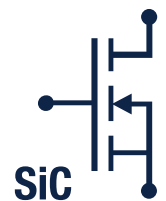
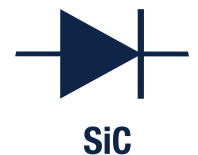

BCD (BIPOLAR-CMOS-DMOS)

BCD (BIPOLAR-CMOS-DMOS) is a key technology for power ICs. BCD combines the strengths of three different process technologies onto a single chip: Bipolar for precise analog functions, CMOS (Complementary Metal Oxide Semiconductor) for digital design and DMOS (Double Diffused Metal Oxide Semiconductor) for power and high-voltage elements.

This combination of technologies brings many advantages: Improved reliability, reduced electromagnetic interference and smaller chip area. BCD has been widely adopted and continuously improved to address a broad range of products and applications in the fields of power management, analog data acquisition and power actuators.

BCD technology is used widely in the automotive industry and products are found in active suspension, braking, transmission, airbag, car audio and notably engine management and charging applications. A key engine management application is for fully integrated System-on-Chip solutions for CO₂ reducing Gasoline Direct Injection (GDI) systems. For EV charging BCD is ideal for battery management systems (BMS).

1200 V AEC-Q101 qualified technologies for EV charging

High voltage rectifier and thyristor technologies are the keys to develop robust, immune AC line connected systems exhibiting high power density. ST has developed a set of automotive grade technologies for full rectification functions in the low frequency (AC line) or high frequency ranges (DC-DC conversion). AEC-Q101 qualified, this rectifier diode and thyristor series are available to design robust converters compatible with the most stringent electromagnetic norms such as burst or surge voltages.

TRANSIL™

TRANSIL™ is a key planar technology for Automotive TVS series designed to protect automotive sensitive circuits against surges as defined in ISO 7637-2 and ISO 16750 tests A and B also called load-dump (battery lines), ISO7637-3 (data lines) and ESD as defined in ISO 10605. Protection is also provided against other perturbations generated by elements like ignition, relay contacts, alternators, injectors, SMPS, etc.

This technology is compatible with high-end circuits where low leakage current and high junction temperatures are required to provide reliability and stability over time.

STPOWER

Leading-edge power technologies for both high- and low-voltage applications combined with a full package range and innovative die bonding technologies exemplify ST's innovation in power transistors of the STPOWER™ family.

ST offers a wide portfolio of power MOSFETs ranging from -100 to 1700 V, IGBTs with breakdown voltages ranging from 300 to 1250 V and power bipolar transistors ranging from 15 to 1700 V. Improved thermal design of ST's power electronics systems, and our silicon-carbide (SiC) MOSFETs ensure automotive robustness with the industry's highest temperature rating of 200 °C.

Our extensive STPOWER™ product portfolio combined with state-of-the-art packaging and protection solutions enable designers to create products with high reliability, efficiency and safety.



Development Tools

PRODUCT SELECTORS, SAMPLES, EVALUATION BOARDS

ST provides a set of Smart Selectors tuned to the needs of the Automotive Industry. Once the appropriate products have been selected, a wide range of samples and evaluation boards are available to help you get started and reduce your development times. In addition to boards, ST provides schematics, BOM and Gerber files to facilitate your hardware design and demonstration software packages are available too.

VIPower™ Smart Selector

VIPower's Smart Selector is designed to help and assist users to choose the best VIPower™ high/low-side switch or H-bridge device for their Automotive application.

All you need to do is select a few parameters related to your specific application, and the selector provides the relevant device. Parameters include nominal voltage (12 V for automotive cars or 24 V for trucks), a topology (high-side, low-side or H-bridge), the number of channels and type of load to drive (bulbs, motors, etc.). The selection can be further refined by setting source type (DC or PWM), temperature and PCB type.

The on-line smartest selector for Low/high-side switches and H-bridges

STEP 1 Select Line Voltage (12 V for cars or 24 V for trucks)

STEP 2 Select Device Topology (LS, HS or H-Bridge)

STEP 3 Adjust your choice (channels, load type, etc.)

After the PCB selection... You can then

Get the list of the devices suitable for your application
Click "Compare" for product parametric comparison

Compare	Select CPNs	Technology	Package	P _{tot}	Temp	Thermal
<input checked="" type="checkbox"/>	VN12000	M0-7	PowerSO 16	50	18	■
<input type="checkbox"/>	VN12000	M0-5	PowerSO 12	50	18	■
<input checked="" type="checkbox"/>	VN12000	M0-5	PowerSO 24	50	18	■
<input type="checkbox"/>	VN12000	M0-5	PowerSO 12	50	18	■
<input type="checkbox"/>	VN12000	M0-5	PowerSO 24	50	18	■

Run TwisterSIM, a thermal/electrical simulator to view detailed thermal information or simply to test specific corner conditions.
www.st.com/twistersim



FIND OUT MORE
www.st.com/vipower-smartselector

Easyboards

The Easyboard concept was created to give customers the chance to evaluate products without committing to the expense, time and resources typically needed to design a custom circuit board. Easyboards are simple and low-cost evaluation tools that connect a VIPower™ product to a load. This allows a straightforward evaluation of the device and of all the application functionalities, including the auto-protection capability for hazardous conditions. Each evaluation board includes a VIPower™ device soldered onto a small 2-layers PCB with heavy copper and thermal vias, to support maximum device current and customer-configured thermal relief strategies.

Easyboards come with the following part numbers:

- EV-VNx7xxx: VIPower™ M0-7 High Side Switches single, dual and quad channels for 12 V battery lines
- EV-VNx5Txxx: High Side Switches for 24 V systems
- EV-VNH7xxx: Motor Control solutions



FIND OUT MORE
www.st.com/automotive-evalboards

Dynamic Electro-Thermal simulator for devices in VIPower™ technology

TwisterSIM is a unique Electro-Thermal simulator that helps shorten the design solution cycle by enabling, in a few clicks, complex engineering evaluations with accurate simulations including load-compatibility, wiring harness optimization, fault condition impact analysis, diagnostic behavior analysis and dynamic thermal performance.

A built-in Interactive selector provides a short list of suitable devices based on first level system requirements. It assists you in detailing your actual system configuration with layout, load and driving profile customization to build an accurate model of the final application.

TwisterSIM supports a large selection of low- and high-side drivers and switches as well as H-bridges for Motor Control applications.



FIND OUT MORE
www.st.com/twistersim

VIPower-FINDER

VIPower-FINDER is the application available for Android™ and iOS™ that allows you to explore the ST VIPower™ product portfolio using portable devices. You can easily define the device that best fits your application using the Smart or the parametric search engine. You can also find your product thanks to the efficient part number search engine.

KEY FEATURES

- Smart, parametric or part number search capability
- Technical datasheet download feature and off-line consulting
- Ability to share technical documentation via social media or via email
- Available on Android™ and iOS™ app stores



FIND OUT MORE
www.st.com/vipower-finder

SPC5 AUTOMOTIVE MCU EVALUATION TOOLS: EASIER EVALUATION AND FASTER DEVELOPMENT

A complete range of hardware evaluation and emulation tools supports the SPC5 family of automotive microcontrollers. Discovery and Premium development boards are available to support your development from preliminary evaluation through to advanced solution development.

ST Discovery boards, available for each product line enable a quick and easy way to evaluate the microcontroller's main features. The expansion connector makes it easy to plug-in application and extension modules for rapid prototyping.

ST Premium boards, available for all lines and package, provide user access to the device's complete feature set and functionalities for advanced development. The SPC5 motherboards, used in combination with adapters, enable full access to all of the MCU's signals and peripherals (such as CAN, SPI, LIN, FlexRAY and Ethernet).

The offer is complemented by a series of emulation solutions for high-speed tracing, monitoring and bypassing.

A full range of state-of-the-art tools and software from major third parties is also available for the SPC5 family of automotive microcontrollers.



SPC5 MCUs toolchain

- **Discovery kits**
Quick starter kit for early evaluation
ST Discovery boards enable the user for a quick evaluation of main device features
- **Premium boards**
Complete HW solutions for advanced development
ST Premium boards ensure full access to device's features and functionalities
- **SPC5Studio**
Freeware Eclipse based Development Studio
SPC5Studio integrates our Resources Configurator, Code Generator supporting major third party tools
- **Embedded Software & AUTOSAR Solutions**
Drivers and Software Libraries
Crypto and flash SW Libraries
Core & Instruction Self test Libraries
AUTOSAR MCAL



FIND OUT MORE
www.st.com/auto-sp5-mcu-evaltools



AUTODEVKIT™

A viable, simple, low-cost tool for automotive application engineers

A new development flow and toolset dedicated to the Automotive & Transportation market delivering to engineers the best and easiest way for quick evaluation and rapid prototyping in a common, integrated and flexible environment supporting complete ECU-like development.

AutoDevKit is an Eclipse plug-in running under SPC5Studio Integrated Development Environment.



**AEK MCU Discovery
and Functional
Boards**

KEY FEATURES

- Focus in developing your application without bothering about hardware and software implementation details.
- Assemble and re-assemble hardware and software components without compatibility issues.
- Expand and customize your application adding new components, scaling your microcontroller for cost optimization, changing the compiler, adding a real-time operating system and other Eclipse-compatible plug-ins

**AEKD System
Solution
Demonstrators**

**STSW Embedded
Software**

Find out more at www.st.com/autodevkit

Software download www.st.com/autodevkitsw

Join our Community at <https://community.st.com/autodevkit>

life.augmented



Order code: BRAUTOBC0920

For more information on ST products and solutions, visit www.st.com

© STMicroelectronics - September 2020 - Printed in United Kingdom - All rights reserved
ST and ST logo are trademarks or registered trademarks of STMicroelectronics International NV or its affiliates in the EU and/or other countries. For additional information about ST trademarks, please refer to www.st.com/trademarks.
All other product or service names are the property of their respective owners.



life.augmented