

# MC74HC139A

## Dual 1-of-4 Decoder/ Demultiplexer

### High-Performance Silicon-Gate CMOS

The MC74HC139A is identical in pinout to the LS139. The device inputs are compatible with standard CMOS outputs; with pull-up resistors, they are compatible with LSTTL outputs.

This device consists of two independent 1-of-4 decoders, each of which decodes a two-bit Address to one-of-four active-low outputs. Active-low Selects are provided to facilitate the demultiplexing and cascading functions. The demultiplexing function is accomplished by using the Address inputs to select the desired device output, and utilizing the Select as a data input.

#### Features

- Output Drive Capability: 10 LSTTL Loads
- Outputs Directly Interface to CMOS, NMOS and TTL
- Operating Voltage Range: 2.0 to 6.0 V
- Low Input Current: 1.0  $\mu$ A
- High Noise Immunity Characteristic of CMOS Devices
- In Compliance with the Requirements Defined by JEDEC Standard No. 7 A
- Chip Complexity: 100 FETs or 25 Equivalent Gates
- NLV Prefix for Automotive and Other Applications Requiring Unique Site and Control Change Requirements; AEC-Q100 Qualified and PPAP Capable
- These Devices are Pb-Free, Halogen Free/BFR Free and are RoHS Compliant



ON Semiconductor®

<http://onsemi.com>

#### MARKING DIAGRAMS

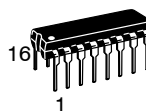

PDIP-16  
N SUFFIX  
CASE 648

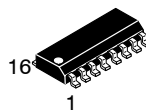

SOIC-16  
D SUFFIX  
CASE 751B

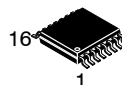
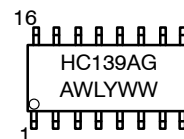

TSSOP-16  
DT SUFFIX  
CASE 948F

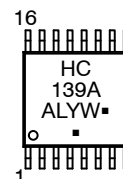

A = Assembly Location  
L, WL = Wafer Lot  
Y, YY = Year  
W, WW = Work Week  
G or ■ = Pb-Free Package

(Note: Microdot may be in either location)

#### ORDERING INFORMATION

See detailed ordering and shipping information in the package dimensions section on page 2 of this data sheet.

# MC74HC139A

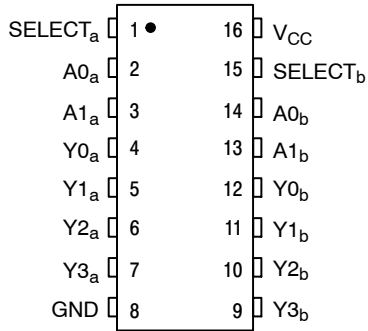

Figure 1. Pin Assignment

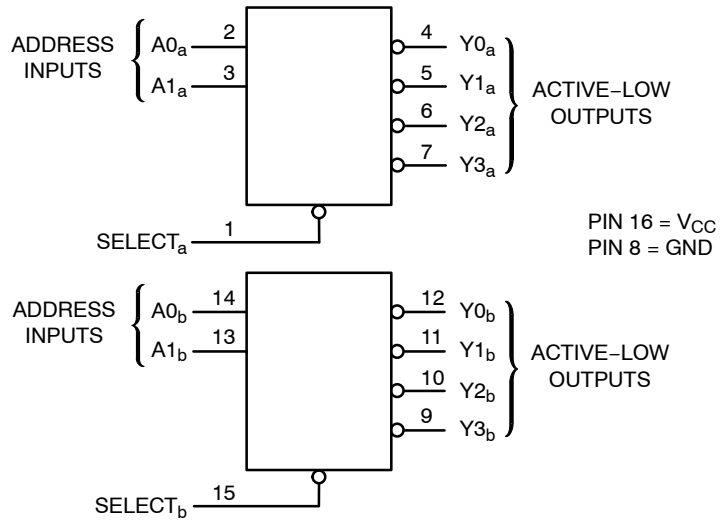

Figure 2. Logic Diagram

## FUNCTION TABLE

Inputs			Outputs			
Select	A1	A0	Y0	Y1	Y2	Y3
H	X	X	H	H	H	H
L	L	L	L	H	H	H
L	L	H	H	L	H	H
L	H	L	H	H	L	H
L	H	H	H	H	H	L

X = don't care

## ORDERING INFORMATION

Device	Package	Shipping†
MC74HC139ANG	PDIP-16 (Pb-Free)	2000 Units / Box
MC74HC139ADG	SOIC-16 (Pb-Free)	48 Units / Rail
MC74HC139ADR2G	SOIC-16 (Pb-Free)	2500 / Tape & Reel
MC74HC139ADTR2G	TSSOP-16 (Pb-Free)	2500 / Tape & Reel
NLV74HC139ADR2G*	SOIC-16 (Pb-Free)	2500 / Tape & Reel
NLV74HC139ADTR2G*	TSSOP-16 (Pb-Free)	2500 / Tape & Reel

†For information on tape and reel specifications, including part orientation and tape sizes, please refer to our Tape and Reel Packaging Specifications Brochure, BRD8011/D.

\*NLV Prefix for Automotive and Other Applications Requiring Unique Site and Control Change Requirements; AEC-Q100 Qualified and PPAP Capable

# MC74HC139A

## MAXIMUM RATINGS

Symbol	Parameter	Value	Unit	
V <sub>CC</sub>	DC Supply Voltage (Referenced to GND)	- 0.5 to + 7.0	V	
V <sub>IN</sub>	DC Input Voltage (Referenced to GND)	- 1.5 to V <sub>CC</sub> + 1.5	V	
V <sub>OUT</sub>	DC Output Voltage (Referenced to GND) (Note 1)	- 0.5 to V <sub>CC</sub> + 0.5	V	
I <sub>IN</sub>	DC Input Current, per Pin	± 20	mA	
I <sub>OUT</sub>	DC Output Current, per Pin	± 25	mA	
I <sub>CC</sub>	DC Supply Current, V <sub>CC</sub> Pin	± 50	mA	
I <sub>GND</sub>	DC Ground Current per Ground Pin	± 50	mA	
T <sub>STG</sub>	Storage Temperature Range	- 65 to + 150	°C	
T <sub>L</sub>	Lead Temperature, 1 mm from Case for 10 Seconds	260	°C	
T <sub>J</sub>	Junction Temperature Under Bias	+ 150	°C	
θ <sub>JA</sub>	Thermal Resistance	PDIP SOIC TSSOP	78 112 148	°C/W
P <sub>D</sub>	Power Dissipation in Still Air at 85°C	PDIP SOIC TSSOP	750 500 450	mW
MSL	Moisture Sensitivity	Level 1		
F <sub>R</sub>	Flammability Rating	Oxygen Index: 30% - 35%	UL 94 V-0 @ 0.125 in	
V <sub>ESD</sub>	ESD Withstand Voltage	Human Body Model (Note 2) Machine Model (Note 3) Charged Device Model (Note 4)	> 2000 > 200 > 1000	V
I <sub>LATCHUP</sub>	Latchup Performance	Above V <sub>CC</sub> and Below GND at 85°C (Note 5)	± 300	mA

Stresses exceeding Maximum Ratings may damage the device. Maximum Ratings are stress ratings only. Functional operation above the Recommended Operating Conditions is not implied. Extended exposure to stresses above the Recommended Operating Conditions may affect device reliability.

1. I<sub>O</sub> absolute maximum rating must be observed.
2. Tested to EIA/JESD22-A114-A.
3. Tested to EIA/JESD22-A115-A.
4. Tested to JESD22-C101-A.
5. Tested to EIA/JESD78.

## RECOMMENDED OPERATING CONDITIONS

Symbol	Parameter	Min	Max	Unit
V <sub>CC</sub>	DC Supply Voltage (Referenced to GND)	2.0	6.0	V
V <sub>IN</sub> , V <sub>OUT</sub>	DC Input Voltage, Output Voltage (Referenced to GND)	0	V <sub>CC</sub>	V
T <sub>A</sub>	Operating Temperature, All Package Types	- 55	+ 125	°C
t <sub>r</sub> , t <sub>f</sub>	Input Rise and Fall Time (Figure 3)	V <sub>CC</sub> = 2.0 V V <sub>CC</sub> = 4.5 V V <sub>CC</sub> = 6.0 V	0 1000 500 400	ns

6. Unused inputs may not be left open. All inputs must be tied to a high-logic voltage level or a low-logic input voltage level.

# MC74HC139A

## DC ELECTRICAL CHARACTERISTICS (Voltages Referenced to GND)

Symbol	Parameter	Test Conditions	V <sub>CC</sub>	Guaranteed Limit			Unit
			V	-55°C to 25°C	≤ 85°C	≤ 125°C	
V <sub>IH</sub>	Minimum High-Level Input Voltage	V <sub>OUT</sub> = 0.1 V or V <sub>CC</sub> - 0.1 V  I <sub>OUT</sub>   ≤ 20 μA	2.0	1.5	1.5	1.5	V
			4.5	3.15	3.15	3.15	
			6.0	4.2	4.2	4.2	
V <sub>IL</sub>	Maximum Low-Level Input Voltage	V <sub>OUT</sub> = 0.1 V or V <sub>CC</sub> - 0.1 V  I <sub>OUT</sub>   ≤ 20 μA	2.0	0.5	0.5	0.5	V
			4.5	1.35	1.35	1.35	
			6.0	1.8	1.8	1.8	
V <sub>OH</sub>	Minimum High-Level Output Voltage	V <sub>IN</sub> = V <sub>IH</sub> or V <sub>IL</sub>  I <sub>OUT</sub>   ≤ 20 μA	2.0	1.9	1.9	1.9	V
			4.5	4.4	4.4	4.4	
			6.0	5.9	5.9	5.9	
		V <sub>IN</sub> = V <sub>IH</sub> or V <sub>IL</sub>  I <sub>OUT</sub>   ≤ 4.0 mA  I <sub>OUT</sub>   ≤ 5.2 mA	4.5	3.98	3.84	3.70	
6.0	5.48	5.34	5.20				
V <sub>OL</sub>	Maximum Low-Level Output Voltage	V <sub>IN</sub> = V <sub>IH</sub> or V <sub>IL</sub>  I <sub>OUT</sub>   ≤ 20 μA	2.0	0.1	0.1	0.1	V
			4.5	0.1	0.1	0.1	
			6.0	0.1	0.1	0.1	
		V <sub>IN</sub> = V <sub>IH</sub> or V <sub>IL</sub>  I <sub>OUT</sub>   ≤ 4.0 mA  I <sub>OUT</sub>   ≤ 5.2 mA	4.5	0.26	0.33	0.40	
6.0	0.26	0.33	0.40				
I <sub>IN</sub>	Maximum Input Leakage Current	V <sub>IN</sub> = V <sub>CC</sub> or GND	6.0	± 0.1	± 1.0	± 1.0	μA
I <sub>CC</sub>	Maximum Quiescent Supply Current (per Package)	V <sub>IN</sub> = V <sub>CC</sub> or GND I <sub>OUT</sub> = 0 μA	6.0	4	40	160	μA

## AC ELECTRICAL CHARACTERISTICS (C<sub>L</sub> = 50 pF, Input t<sub>r</sub> = t<sub>f</sub> = 6.0 ns)

Symbol	Parameter	V <sub>CC</sub>	Guaranteed Limit			Unit
		V	-55°C to 25°C	≤ 85°C	≤ 125°C	
t <sub>PLH</sub> , t <sub>PHL</sub>	Maximum Propagation Delay, Select to Output Y (Figures 1 and 3)	2.0	115	145	175	ns
		4.5	23	29	35	
		6.0	20	25	30	
t <sub>PLH</sub> , t <sub>PHL</sub>	Maximum Propagation Delay, Input A to Output Y (Figures 2 and 3)	2.0	115	145	175	ns
		4.5	23	29	35	
		6.0	20	25	30	
t <sub>TLH</sub> , t <sub>THL</sub>	Maximum Output Transition Time, Any Output (Figures 1 and 3)	2.0	75	95	110	ns
		4.5	15	19	22	
		6.0	13	16	19	
C <sub>in</sub>	Maximum Input Capacitance	-	10	10	10	pF

7. For propagation delays with loads other than 50 pF, and information on typical parametric values, see the ON Semiconductor High-Speed CMOS Data Book (DL129/D).

C <sub>PD</sub>	Power Dissipation Capacitance (Per Decoder) (Note 8)	Typical @ 25°C, V <sub>CC</sub> = 5.0 V	pF
		55	

8. Used to determine the no-load dynamic power consumption: P<sub>D</sub> = C<sub>PD</sub> V<sub>CC</sub><sup>2</sup>f + I<sub>CC</sub> V<sub>CC</sub>.

# MC74HC139A

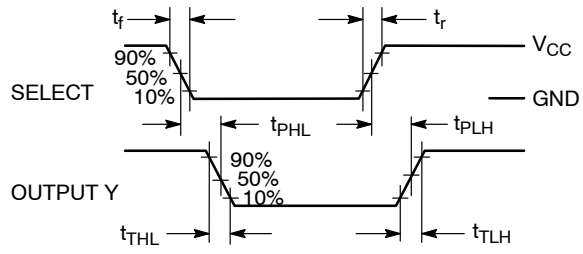

Figure 3. Switching Waveform

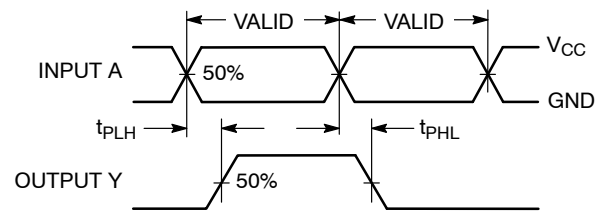
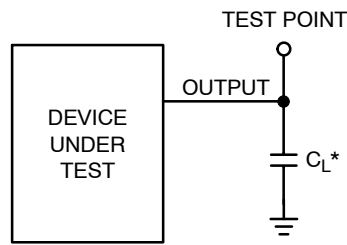

Figure 4. Switching Waveform



\* Includes all probe and jig capacitance

Figure 5. Test Circuit

# MC74HC139A

## PIN DESCRIPTIONS

### ADDRESS INPUTS

#### **A0<sub>a</sub>, A1<sub>a</sub>, A0<sub>b</sub>, A1<sub>b</sub> (Pins 2, 3, 14, 13)**

Address inputs. These inputs, when the respective 1-of-4 decoder is enabled, determine which of its four active-low outputs is selected.

### CONTROL INPUTS

#### **Select<sub>a</sub>, Select<sub>b</sub> (Pins 1, 15)**

Active-low select inputs. For a low level on this input, the outputs for that particular decoder follow the Address

inputs. A high level on this input forces all outputs to a high level.

### OUTPUTS

#### **Y0<sub>a</sub> – Y3<sub>a</sub>, Y0<sub>b</sub> – Y3<sub>b</sub> (Pins 4 – 7, 12, 11, 10, 9)**

Active-low outputs. These outputs assume a low level when addressed and the appropriate Select input is active. These outputs remain high when not addressed or the appropriate Select input is inactive.

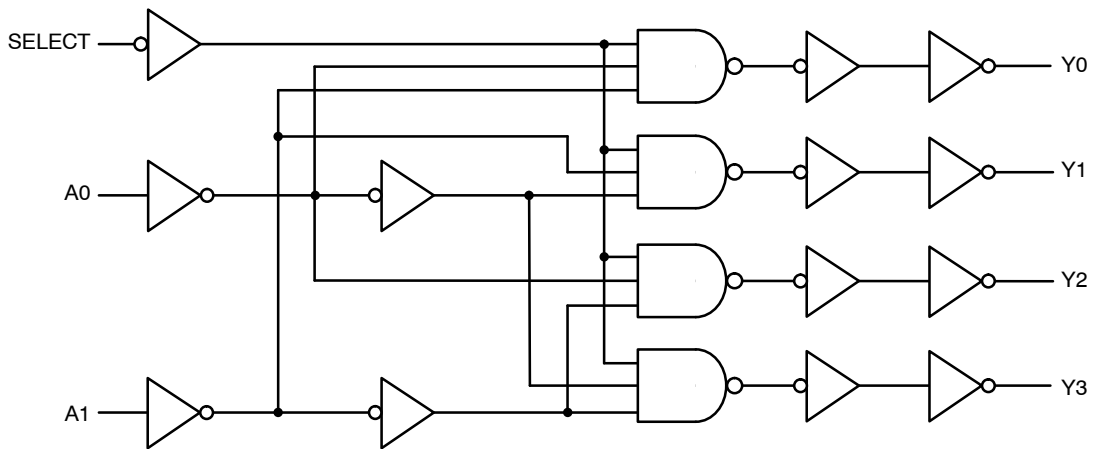
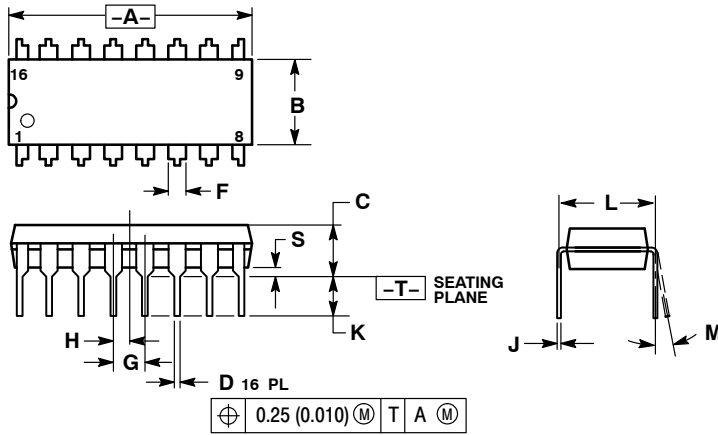

**Figure 6. Expanded Logic Diagram**  
(1/2 of Device)

# MC74HC139A

## PACKAGE DIMENSIONS

PDIP-16  
CASE 648-08  
ISSUE T



NOTES:

1. DIMENSIONING AND TOLERANCING PER ANSI Y14.5M, 1982.
2. CONTROLLING DIMENSION: INCH.
3. DIMENSION L TO CENTER OF LEADS WHEN FORMED PARALLEL.
4. DIMENSION B DOES NOT INCLUDE MOLD FLASH.
5. ROUNDED CORNERS OPTIONAL.

DIM	INCHES		MILLIMETERS	
	MIN	MAX	MIN	MAX
A	0.740	0.770	18.80	19.55
B	0.250	0.270	6.35	6.85
C	0.145	0.175	3.69	4.44
D	0.015	0.021	0.39	0.53
F	0.040	0.70	1.02	1.77
G	0.100 BSC		2.54 BSC	
H	0.050 BSC		1.27 BSC	
J	0.008	0.015	0.21	0.38
K	0.110	0.130	2.80	3.30
L	0.295	0.305	7.50	7.74
M	0°	10°	0°	10°
S	0.020	0.040	0.51	1.01

# MC74HC139A

## PACKAGE DIMENSIONS

SOIC-16  
CASE 751B-05  
ISSUE K



**NOTES:**

1. DIMENSIONING AND TOLERANCING PER ANSI Y14.5M, 1982.
2. CONTROLLING DIMENSION: MILLIMETER.
3. DIMENSIONS A AND B DO NOT INCLUDE MOLD PROTRUSION.
4. MAXIMUM MOLD PROTRUSION 0.15 (0.006) PER SIDE.
5. DIMENSION D DOES NOT INCLUDE DAMBAR PROTRUSION. ALLOWABLE DAMBAR PROTRUSION SHALL BE 0.127 (0.005) TOTAL IN EXCESS OF THE D DIMENSION AT MAXIMUM MATERIAL CONDITION.

DIM	MILLIMETERS		INCHES	
	MIN	MAX	MIN	MAX
A	9.80	10.00	0.386	0.393
B	3.80	4.00	0.150	0.157
C	1.35	1.75	0.054	0.068
D	0.35	0.49	0.014	0.019
F	0.40	1.25	0.016	0.049
G	1.27 BSC		0.050 BSC	
J	0.19	0.25	0.008	0.009
K	0.10	0.25	0.004	0.009
M	0°	7°	0°	7°
P	5.80	6.20	0.229	0.244
R	0.25	0.50	0.010	0.019

### SOLDERING FOOTPRINT\*

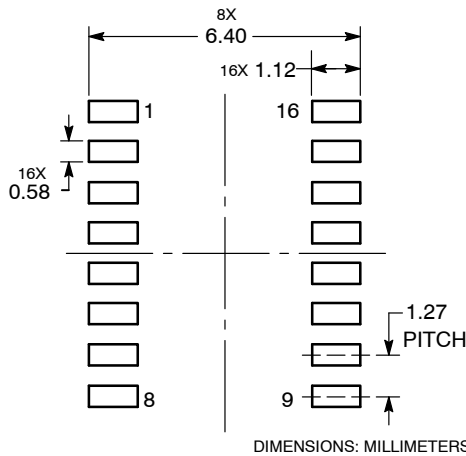

DIMENSIONS: MILLIMETERS

\*For additional information on our Pb-Free strategy and soldering details, please download the ON Semiconductor Soldering and Mounting Techniques Reference Manual, SOLDERRM/D.



# MC74HC139A

## PACKAGE DIMENSIONS

TSSOP-16  
CASE 948F-01  
ISSUE B



NOTES:

1. DIMENSIONING AND TOLERANCING PER ANSI Y14.5M, 1982.
2. CONTROLLING DIMENSION: MILLIMETER.
3. DIMENSION A DOES NOT INCLUDE MOLD FLASH. PROTRUSIONS OR GATE BURRS. MOLD FLASH OR GATE BURRS SHALL NOT EXCEED 0.15 (0.006) PER SIDE.
4. DIMENSION B DOES NOT INCLUDE INTERLEAD FLASH OR PROTRUSION. INTERLEAD FLASH OR PROTRUSION SHALL NOT EXCEED 0.25 (0.010) PER SIDE.
5. DIMENSION K DOES NOT INCLUDE DAMBAR PROTRUSION. ALLOWABLE DAMBAR PROTRUSION SHALL BE 0.08 (0.003) TOTAL IN EXCESS OF THE K DIMENSION AT MAXIMUM MATERIAL CONDITION.
6. TERMINAL NUMBERS ARE SHOWN FOR REFERENCE ONLY.
7. DIMENSION A AND B ARE TO BE DETERMINED AT DATUM PLANE -W-.

DIM	MILLIMETERS		INCHES	
	MIN	MAX	MIN	MAX
A	4.90	5.10	0.193	0.200
B	4.30	4.50	0.169	0.177
C	---	1.20	---	0.047
D	0.05	0.15	0.002	0.006
F	0.50	0.75	0.020	0.030
G	0.65 BSC		0.026 BSC	
H	0.18	0.28	0.007	0.011
J	0.09	0.20	0.004	0.008
J1	0.09	0.16	0.004	0.006
K	0.19	0.30	0.007	0.012
K1	0.19	0.25	0.007	0.010
L	6.40 BSC		0.252 BSC	
M	0°	8°	0°	8°

### SOLDERING FOOTPRINT

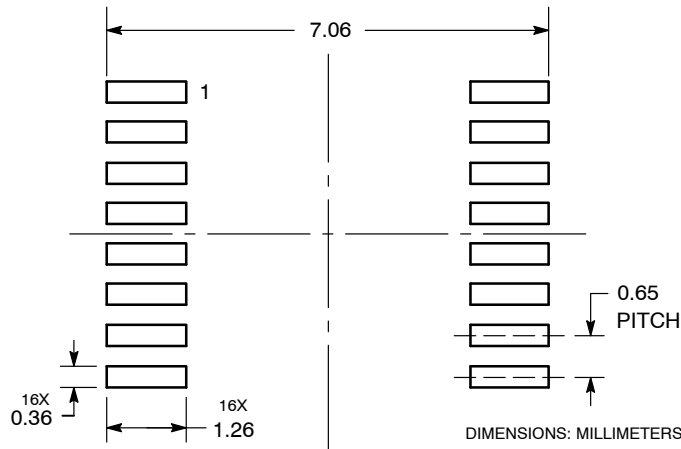

\*For additional information on our Pb-Free strategy and soldering details, please download the ON Semiconductor Soldering and Mounting Techniques Reference Manual, SOLDERRM/D.

**ON Semiconductor** and **ON** are registered trademarks of Semiconductor Components Industries, LLC (SCILLC). SCILLC owns the rights to a number of patents, trademarks, copyrights, trade secrets, and other intellectual property. A listing of SCILLC's product/patent coverage may be accessed at [www.onsemi.com/site/pdf/Patent-Marking.pdf](http://www.onsemi.com/site/pdf/Patent-Marking.pdf). SCILLC reserves the right to make changes without further notice to any products herein. SCILLC makes no warranty, representation or guarantee regarding the suitability of its products for any particular purpose, nor does SCILLC assume any liability arising out of the application or use of any product or circuit, and specifically disclaims any and all liability, including without limitation special, consequential or incidental damages. "Typical" parameters which may be provided in SCILLC data sheets and/or specifications can and do vary in different applications and actual performance may vary over time. All operating parameters, including "Typicals" must be validated for each customer application by customer's technical experts. SCILLC does not convey any license under its patent rights nor the rights of others. SCILLC products are not designed, intended, or authorized for use as components in systems intended for surgical implant into the body, or other applications intended to support or sustain life, or for any other application in which the failure of the SCILLC product could create a situation where personal injury or death may occur. Should Buyer purchase or use SCILLC products for any such unintended or unauthorized application, Buyer shall indemnify and hold SCILLC and its officers, employees, subsidiaries, affiliates, and distributors harmless against all claims, costs, damages, and expenses, and reasonable attorney fees arising out of, directly or indirectly, any claim of personal injury or death associated with such unintended or unauthorized use, even if such claim alleges that SCILLC was negligent regarding the design or manufacture of the part. SCILLC is an Equal Opportunity/Affirmative Action Employer. This literature is subject to all applicable copyright laws and is not for resale in any manner.

## PUBLICATION ORDERING INFORMATION

### LITERATURE FULFILLMENT:

Literature Distribution Center for ON Semiconductor  
P.O. Box 5163, Denver, Colorado 80217 USA  
**Phone:** 303-675-2175 or 800-344-3860 Toll Free USA/Canada  
**Fax:** 303-675-2176 or 800-344-3867 Toll Free USA/Canada  
**Email:** [orderlit@onsemi.com](mailto:orderlit@onsemi.com)

**N. American Technical Support:** 800-282-9855 Toll Free  
USA/Canada  
**Europe, Middle East and Africa Technical Support:**  
Phone: 421 33 790 2910  
**Japan Customer Focus Center**  
Phone: 81-3-5817-1050

**ON Semiconductor Website:** [www.onsemi.com](http://www.onsemi.com)  
**Order Literature:** <http://www.onsemi.com/orderlit>  
For additional information, please contact your local  
Sales Representative