

Silicon SPDT Switch, Reflective, 100 MHz to 44 GHz

**FEATURES**

- ▶ Ultrawideband frequency range: 100 MHz to 44 GHz
- ▶ Reflective design
- ▶ Low insertion loss with impedance match
  - ▶ 1.0 dB typical to 18 GHz
  - ▶ 1.4 dB typical to 40 GHz
  - ▶ 1.7 dB typical to 44 GHz
- ▶ Low insertion loss without impedance match
  - ▶ 0.9 dB typical to 18 GHz
  - ▶ 1.7 dB typical to 40 GHz
  - ▶ 2.1 dB typical to 44 GHz
- ▶ High input linearity
  - ▶ P1dB: 27.5 dBm typical
  - ▶ IP3: 50 dBm typical
- ▶ High RF input power handling
  - ▶ Through path: 27 dBm
  - ▶ Hot switching: 27 dBm
- ▶ No low frequency spurious
- ▶ RF settling time (50%  $V_{CTRL}$  to 0.1 dB of final RF output): 17 ns
- ▶ 12-terminal, 2.25 mm × 2.25 mm LGA package

**ENHANCED PRODUCT FEATURES**

- ▶ Supports defense and aerospace applications (AQEC standard)
- ▶ Military temperature range (-55°C to +105°C)
- ▶ Controlled manufacturing baseline
- ▶ 1 assembly/test site
- ▶ 1 fabrication site
- ▶ Product change notification
- ▶ Qualification data available on request

**APPLICATIONS**

- ▶ Industrial scanners
- ▶ Test and instrumentation
- ▶ Cellular infrastructure: 5G mmWave
- ▶ Military radios, radars, electronic counter measures (ECMs)
- ▶ Microwave radios and very small aperture terminals (VSATs)

**FUNCTIONAL BLOCK DIAGRAM**

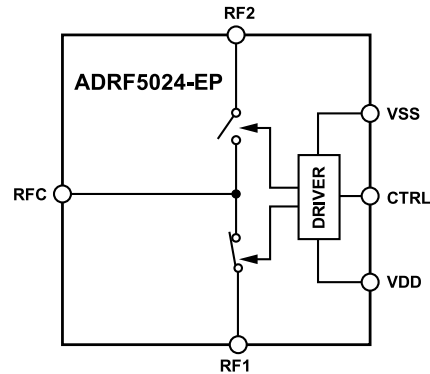

Figure 1.

**GENERAL DESCRIPTION**

The ADRF5024-EP is a reflective, SPDT switch manufactured in the silicon process.

This switch operates from 100 MHz to 44 GHz with >1.7 dB of insertion loss and >35 dB of isolation. The ADRF5024-EP has an RF input power handling capability of 27 dBm for both the through path and hot switching.

The ADRF5024-EP draws a low current of 14  $\mu$ A on the positive supply of +3.3 V and 120  $\mu$ A on negative supply of -3.3 V. The device employs complementary metal-oxide semiconductor (CMOS)/low voltage transistor to transistor logic (LVTTL)-compatible controls.

The ADRF5024-EP RF ports are designed to match a characteristic impedance of 50  $\Omega$ . For ultrawideband products, impedance matching on the RF transmission lines can further optimize high frequency insertion loss and return loss characteristics. Refer to the [Electrical Specifications](#) section, the [Typical Performance Characteristics](#) section, and the [ADRF5024](#) data sheet for more details.

The ADRF5024-EP comes in a 2.25 mm × 2.25 mm, 12-terminal, RoHS-compliant, land grid array (LGA) package and can operate between -55°C to +105°C.

Additional application and technical information can be found in the [ADRF5024](#) data sheet.

**TABLE OF CONTENTS**

Features.....	1	Electrostatic Discharge (ESD) Ratings.....	5
Enhanced Product Features.....	1	ESD Ratings for ADRF5024-EP.....	5
Applications.....	1	ESD Caution.....	5
Functional Block Diagram.....	1	Pin Configuration and Function Descriptions.....	6
General Description.....	1	Interface Schematics.....	6
Specifications.....	3	Typical Performance Characteristics.....	7
Electrical Specifications.....	3	Insertion Loss and Return Loss.....	7
Absolute Maximum Ratings.....	5	Outline Dimensions.....	8
Thermal Resistance.....	5	Ordering Guide.....	8
Power Derating Curve.....	5		

**REVISION HISTORY****11/2022—Rev. 0 to Rev. A**

Changes to RF Input Power Parameter, Table 1.....	3
Changes to RF Input Power Parameter, Table 2.....	5

**10/2020—Revision 0: Initial Version**

## SPECIFICATIONS

## ELECTRICAL SPECIFICATIONS

VDD = 3.3 V, VSS = -3.3 V, digital control voltage ( $V_{CTRL}$ ) = 0 V or VDD, and  $T_{CASE}$  = 25°C for a 50  $\Omega$  system, unless otherwise noted.

Table 1.

Parameter	Symbol	Test Conditions/Comments	Min	Typ	Max	Unit
FREQUENCY RANGE	f		100		44,000	MHz
INSERTION LOSS						
Between RFC and RF1/RF2 (On)						
With Impedance Match		See <a href="#">Figure 6</a>				
		100 MHz to 18 GHz		1.0		dB
		18 GHz to 26 GHz		1.4		dB
		26 GHz to 35 GHz		1.4		dB
		35 GHz to 40 GHz		1.4		dB
		40 GHz to 44 GHz		1.7		dB
Without Impedance Match		See <a href="#">Figure 7</a>				
		100 MHz to 18 GHz		0.9		dB
		18 GHz to 26 GHz		1.1		dB
		26 GHz to 35 GHz		1.5		dB
		35 GHz to 40 GHz		1.7		dB
		40 GHz to 44 GHz		2.1		dB
RETURN LOSS						
RFC and RF1/RF2 (On)						
With Impedance Match		See the <a href="#">ADRF5024</a> data sheet for the figure				
		100 MHz to 18 GHz		17		dB
		18 GHz to 26 GHz		13		dB
		26 GHz to 35 GHz		13		dB
		35 GHz to 40 GHz		18		dB
		40 GHz to 44 GHz		12		dB
Without Impedance Match		See the <a href="#">ADRF5024</a> data sheet for the figure				
		100 MHz to 18 GHz		21		dB
		18 GHz to 26 GHz		17		dB
		26 GHz to 35 GHz		13		dB
		35 GHz to 40 GHz		12		dB
		40 GHz to 44 GHz		10		dB
ISOLATION						
Between RFC and RF1/RF2						
		100 MHz to 18 GHz		42		dB
		18 GHz to 26 GHz		41		dB
		26 GHz to 35 GHz		38		dB
		35 GHz to 40 GHz		36		dB
		40 GHz to 44 GHz		35		dB
Between RF1 and RF2						
		100 MHz to 18 GHz		47		dB
		18 GHz to 26 GHz		45		dB
		26 GHz to 35 GHz		44		dB
		35 GHz to 40 GHz		42		dB
		40 GHz to 44 GHz		38		dB
SWITCHING CHARACTERISTICS						
Rise and Fall Time	$t_{RISE}$ , $t_{FALL}$	10% to 90% of RF output		2		ns
On and Off Time	$t_{ON}$ , $t_{OFF}$	50% $V_{CTRL}$ to 90% of RF output		10		ns
RF Settling Time		50% $V_{CTRL}$ to 0.1 dB of final RF output		17		ns
0.1 dB						

## SPECIFICATIONS

Table 1. (Continued)

Parameter	Symbol	Test Conditions/Comments	Min	Typ	Max	Unit
0.05 dB		50% $V_{CTRL}$ to 0.05 dB of final RF output		22		ns
INPUT LINEARITY <sup>1</sup>		200 MHz to 40 GHz				
1 dB Power Compression	P1dB			27.5		dBm
Third-Order Intercept	IP3	Two tone input power = 12 dBm each tone, $\Delta f = 1$ MHz		50		dBm
SUPPLY CURRENT		VDD and VSS pins				
Positive Supply Current	$I_{DD}$			14		$\mu$ A
Negative Supply Current	$I_{SS}$			120		$\mu$ A
DIGITAL CONTROL INPUTS		CTRL pin				
Voltage						
Low	$V_{INL}$		0		0.8	V
High	$V_{INH}$		1.2		3.3	V
Current						
Low and High	$I_{INL}, I_{INH}$			<1		$\mu$ A
RECOMMENDED OPERATING CONDITONS						
Supply Voltage						
Positive	$V_{DD}$		3.15		3.45	V
Negative	$V_{SS}$		-3.45		-3.15	V
Digital Control Voltage	$V_{CTRL}$		0		$V_{DD}$	V
RF Input Power <sup>2</sup>	$P_{IN}$	Frequency = 200 MHz to 40 GHz, $T_{CASE} = 85^{\circ}C^3$				
Input at RFC						
Through Path		RF signal is applied to RFC			27	dBm
Hot Switching		RF signal is present at RFC while switching between RF1 and RF2			27	dBm
Input at RFx						
Through Path		RF signal is applied through connected RFx			26	dBm
Hot Switching		RF signal is present at RFx while switching between RF1 and RF2			26	dBm
Case Temperature	$T_{CASE}$		-55		+105	$^{\circ}C$

<sup>1</sup> For input linearity performance vs. frequency, see the [ADRF5024](#) data sheet.

<sup>2</sup> For power derating vs. frequency, see the [ADRF5024](#) data sheet.

<sup>3</sup> For 105 $^{\circ}C$  operation, the power handling degrades from the  $T_{CASE} = 85^{\circ}C$  specification by 3 dB.

## ABSOLUTE MAXIMUM RATINGS

For the recommended operating conditions, see [Table 1](#).

**Table 2.**

Parameter	Rating
Positive Supply Voltage	-0.3 V to +3.6 V
Negative Supply Voltage	-3.6 V to +0.3 V
Digital Control Input Voltage	
Voltage	-0.3 V to VDD + 0.3 V
Current	3 mA
RF Input Power <sup>1</sup> (f = 200 MHz to 40 GHz, T <sub>CASE</sub> = 85°C <sup>2</sup> )	
Input at RFC	
Through Path	27.5 dBm
Hot Switching	27.5 dBm
Input at RFx	
Through Path	26.5 dBm
Hot Switching	26.5 dBm
RF Input Power Under Unbiased Condition <sup>1</sup> (VDD, VSS = 0 V)	21 dBm
Temperature	
Junction, T <sub>J</sub>	135°C
Storage Range	-65°C to +150°C
Reflow	260°C

<sup>1</sup> For power derating vs. frequency, see the [ADRF5024](#) data sheet. This power derating is applicable for the insertion loss path and the hot switching power specifications.

<sup>2</sup> For 105°C operation, the power handling degrades from the TC = 85°C specification by 3 dB.

Stresses at or above those listed under Absolute Maximum Ratings may cause permanent damage to the product. This is a stress rating only; functional operation of the product at these or any other conditions above those indicated in the operational section of this specification is not implied. Operation beyond the maximum operating conditions for extended periods may affect product reliability.

Only one absolute maximum rating can be applied at any one time.

## THERMAL RESISTANCE

Thermal performance is directly linked to the printed circuit board (PCB) design and operating environment. Careful attention to PCB thermal design is required.

$\theta_{JC}$  is the junction to case bottom (channel to package bottom) thermal resistance.

**Table 3. Thermal Resistance**

Package Type	$\theta_{JC}$	Unit
CC-12-3, Through Path	352	°C/W

## POWER DERATING CURVE

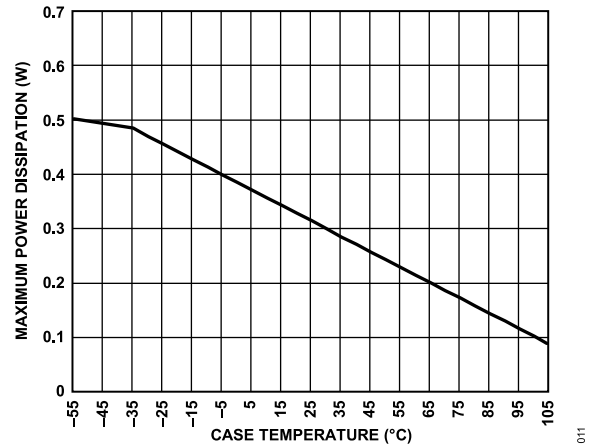

**Figure 2. Maximum Power Dissipation vs. Case Temperature**

For more information on power derating curves, see the [ADRF5024](#) data sheet.

## ELECTROSTATIC DISCHARGE (ESD) RATINGS

The following ESD information is provided for handling of ESD-sensitive devices in an ESD protected area only.

Human body model (HBM) per ANSI/ESDA/JEDDEC JS-001.

Charged device model (CDM) per ANSI/ESDA/JEDDEC JS-002.

## ESD RATINGS FOR ADRF5024-EP

**Table 4. ADRF5024-EP, 12-Terminal LGA**

ESD Model	Withstand Threshold (V)	Class
HBM		
RFC, RF1, and RF2 Pins	500	1B
Digital Pins	2000	1B
CDM	1250	IV

## ESD CAUTION



**ESD (electrostatic discharge) sensitive device.** Charged devices and circuit boards can discharge without detection. Although this product features patented or proprietary protection circuitry, damage may occur on devices subjected to high energy ESD. Therefore, proper ESD precautions should be taken to avoid performance degradation or loss of functionality.

**PIN CONFIGURATION AND FUNCTION DESCRIPTIONS**

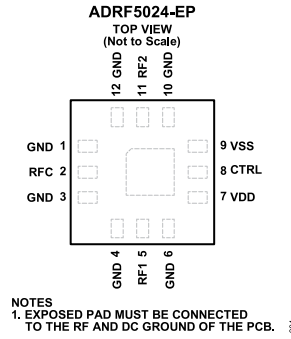
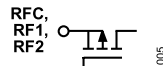

**Figure 3. Pin Configuration (Top View)**

**Table 5. Pin Function Descriptions**

Pin No.	Mnemonic	Description
1, 3, 4, 6, 10, 12	GND	Ground. The GND pins must be connected to the RF and dc ground of the PCB.
2	RFC	RF Common Port. RFC is dc-coupled to 0 V and ac matched to 50 Ω. When the RF line potential is equal to 0 V dc, a dc blocking capacitor is not necessary. See Figure 4 for the interface schematic.
5	RF1	RF Port 1. RF1 is dc-coupled to 0 V and ac matched to 50 Ω. When the RF line potential is equal to 0 V dc, a dc blocking capacitor is not necessary. See Figure 4 for the interface schematic.
7	VDD	Positive Supply Voltage. See Figure 5 for the interface schematic.
8	CTRL	Control Input Voltage. See Figure 5 for the interface schematic.
9	VSS	Negative Supply Voltage.
11	RF2	RF Port 2. RF2 is dc-coupled to 0 V and ac matched to 50 Ω. When the RF line potential is equal to 0 V dc, a dc blocking capacitor is not necessary. See Figure 4 for the interface schematic.
	EPAD	Exposed Pad. The exposed pad must be connected to the RF and dc ground of the PCB.

**INTERFACE SCHEMATICS**



**Figure 4. RFx Pins Interface Schematic**

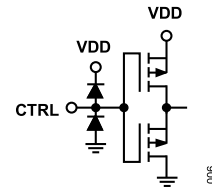

**Figure 5. CTRL Interface Schematic**

**TYPICAL PERFORMANCE CHARACTERISTICS**

**INSERTION LOSS AND RETURN LOSS**

VDD = 3.3 V, VSS = -3.3 V, V<sub>CTRL</sub> = 0 V or VDD, and T<sub>CASE</sub> = 25°C for a 50 Ω system, unless otherwise noted.

Insertion loss and return loss are measured on the probe matrix board using ground-signal-ground (GSG) probes close to the RFx pins. See the [ADRF5024](#) data sheet for details on the evaluation and probe matrix boards.

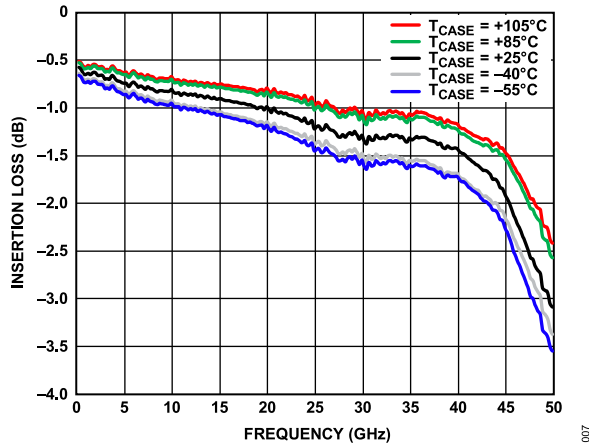

Figure 6. Insertion Loss vs. Frequency with Impedance Match

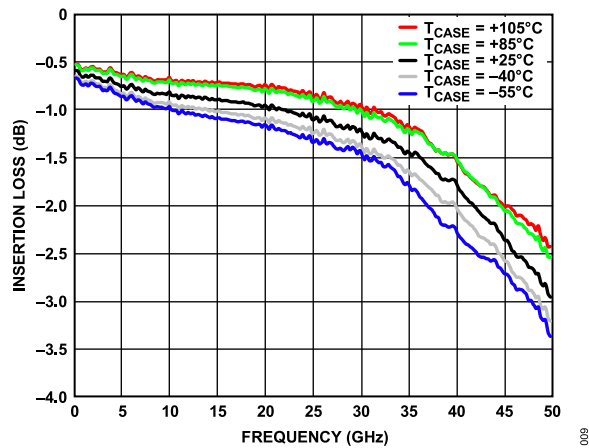

Figure 7. Insertion Loss vs. Frequency Without Impedance Match

OUTLINE DIMENSIONS

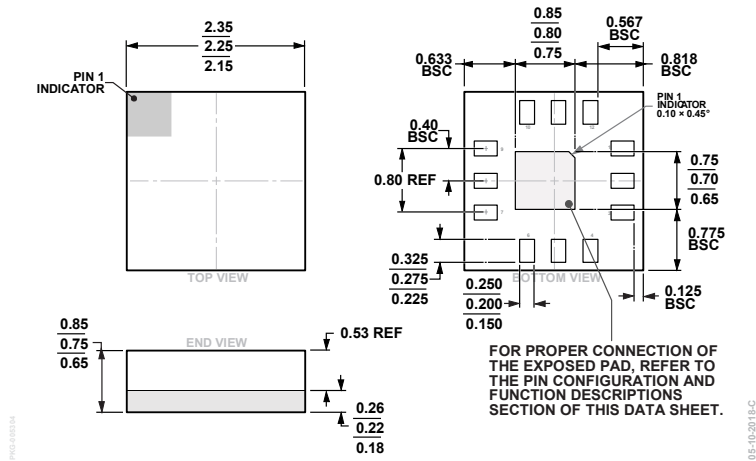

Figure 8. 12-Terminal Land Grid Array [LGA]  
 2.25 mm × 2.25 mm Body and 0.75 mm Package Height  
 (CC-12-3)  
 Dimensions shown in millimeters

ORDERING GUIDE

Table 6.

Model <sup>1</sup>	Temperature Range	Package Description	Package Option	Marking Code
ADRF5024SCCZ-EP	-55°C to +105°C	12-Terminal Land Grid Array [LGA]	CC-12-3	S4
ADRF5024SCCZ-EPR7	-55°C to +105°C	12-Terminal Land Grid Array [LGA]	CC-12-3	S4

<sup>1</sup> Z = RoHS Compliant Part.