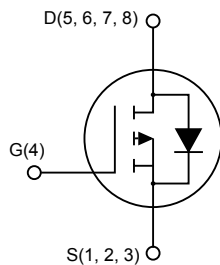
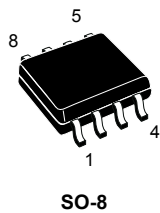


## P-channel -40 V, 12.5 mΩ typ., -10 A STripFET F6 Power MOSFET in SO-8 package



AM01475v4

### Features

Order code	$V_{DS}$	$R_{DS(on)}$ max.	$I_D$
STS10P4LLF6	-40 V	15 mΩ	-10 A

- Very low on-resistance
- Very low gate charge
- High avalanche ruggedness
- Low gate drive power loss

### Applications

- Switching applications

### Description

This device is a P-channel Power MOSFET developed using the STripFET F6 technology, with a new trench gate structure. The resulting Power MOSFET exhibits very low  $R_{DS(on)}$  in all packages.



#### Product status link

[STS10P4LLF6](#)

#### Product summary

<b>Order code</b>	STS10P4LLF6
<b>Marking</b>	10P4L
<b>Package</b>	SO-8
<b>Packing</b>	Tape and reel

# 1 Electrical ratings

**Table 1. Absolute maximum ratings**

Symbol	Parameter	Value	Unit
$V_{DS}$	Drain-source voltage	-40	V
$V_{GS}$	Gate-source voltage	$\pm 20$	V
$I_D$	Drain current (continuous) at $T_{amb} = 25\text{ }^\circ\text{C}$	-10	A
	Drain current (continuous) at $T_{amb} = 100\text{ }^\circ\text{C}$	-5.6	A
$I_{DM}^{(1)}$	Drain current (pulsed)	-40	A
$P_{TOT}$	Total power dissipation at $T_{amb} = 25\text{ }^\circ\text{C}$	2.7	W
$T_{stg}$	Storage temperature	-55 to 150	$^\circ\text{C}$
$T_J$	Operating junction temperature	150	$^\circ\text{C}$

1. Pulse width limited by safe operating area.

**Table 2. Thermal data**

Symbol	Parameter	Value	Unit
$R_{thJA}^{(1)}$	Thermal resistance, junction-to-ambient	47	$^\circ\text{C/W}$

1. When mounted on 1 inch<sup>2</sup> FR-4 board, 2 oz. Cu.,  $t \leq 10$  sec.

## 2 Electrical characteristics

( $T_C = 25\text{ °C}$  unless otherwise specified)

**Table 3. Static**

Symbol	Parameter	Test conditions	Min.	Typ.	Max.	Unit
$V_{(BR)DSS}$	Drain-source breakdown voltage	$I_D = -250\ \mu\text{A}$	-40			V
$I_{DSS}$	Zero gate voltage drain current	$V_{DS} = -40\ \text{V}$			-1	$\mu\text{A}$
		$V_{DS} = -40\ \text{V}, T_C = 125\text{ °C}$			-10	$\mu\text{A}$
$I_{GSS}$	Gate-body leakage current	$V_{DS} = 0\ \text{V}, V_{GS} = \pm 20\ \text{V}$			$\pm 100$	nA
$V_{GS(th)}$	Gate threshold voltage	$V_{DS} = V_{GS}, I_D = -250\ \mu\text{A}$	-1		-2.5	V
$R_{DS(on)}$	Static drain-source on-resistance	$V_{GS} = -10\ \text{V}, I_D = -3\ \text{A}$		12.5	15	m $\Omega$
		$V_{GS} = -4.5\ \text{V}, I_D = -3\ \text{A}$		17	20	

**Table 4. Dynamic**

Symbol	Parameter	Test conditions	Min.	Typ.	Max.	Unit
$C_{iss}$	Input capacitance	$V_{DS} = -25\ \text{V}, f = 1\ \text{MHz}, V_{GS} = 0\ \text{V}$	-	3525	-	pF
$C_{oss}$	Output capacitance		-	344	-	pF
$C_{riss}$	Reverse transfer capacitance		-	238.5	-	pF
$Q_g$	Total gate charge	$V_{DD} = -20\ \text{V}, I_D = -10\ \text{A}, V_{GS} = -4.5\ \text{V}$ (see Figure 13. Test circuit for gate charge behavior)	-	34	-	nC
$Q_{gs}$	Gate-source charge		-	11.3	-	nC
$Q_{gd}$	Gate-drain charge		-	13.8	-	nC

**Table 5. Switching times**

Symbol	Parameter	Test conditions	Min.	Typ.	Max.	Unit
$t_{d(on)}$	Turn-on delay time	$V_{DD} = -20\ \text{V}, I_D = -5\ \text{A},$ $R_G = 4.7\ \Omega, V_{GS} = -10\ \text{V}$ (see Figure 12. Test circuit for resistive load switching times)	-	49.4	-	ns
$t_r$	Rise time		-	60.6	-	ns
$t_{d(off)}$	Turn-off-delay time		-	170	-	ns
$t_f$	Fall time		-	20	-	ns

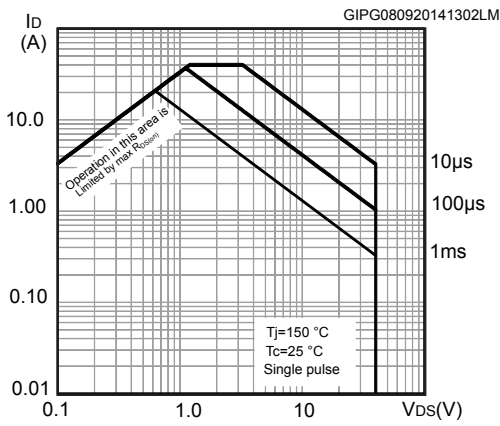
**Table 6. Source drain diode**

Symbol	Parameter	Test conditions	Min.	Typ.	Max.	Unit
$V_{SD}^{(1)}$	Forward on voltage	$V_{GS} = 0\ \text{V}, I_{SD} = -3\ \text{A}$	-		-1.1	V
$t_{rr}$	Reverse recovery time	$I_{SD} = -5\ \text{A}, di/dt = 100\ \text{A}/\mu\text{s},$ $V_{DD} = -32\ \text{V}, T_J = 150\text{ °C}$ (see Figure 14. Test circuit for inductive load switching and diode recovery times)	-	29		ns
$Q_{rr}$	Reverse recovery charge		-	27.6		nC
$I_{RRM}$	Reverse recovery current		-	-1.9		A

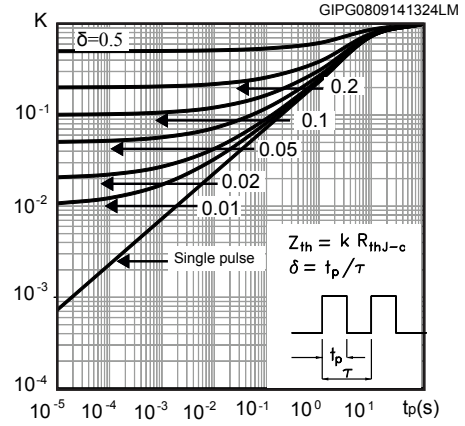
1. Pulse test: pulse duration = 300  $\mu\text{s}$ , duty cycle 1.5%.

## 2.1 Electrical characteristics (curves)

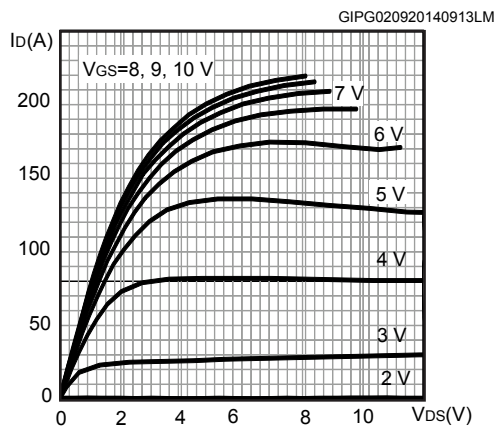
**Figure 1. Safe operating area**



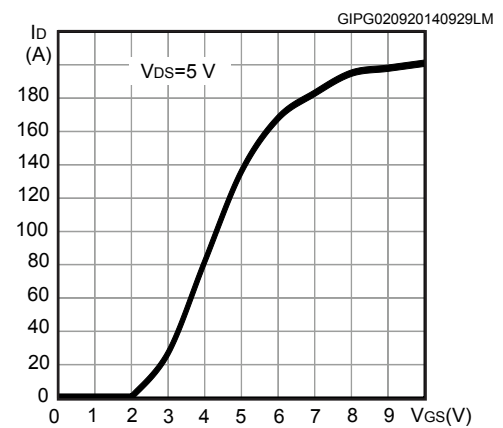
**Figure 2. Thermal impedance**



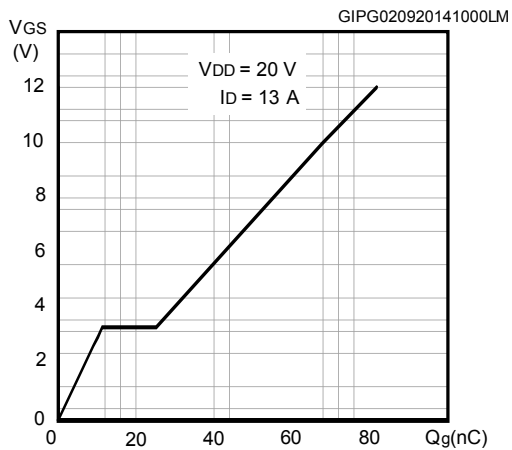
**Figure 3. Output characteristics**



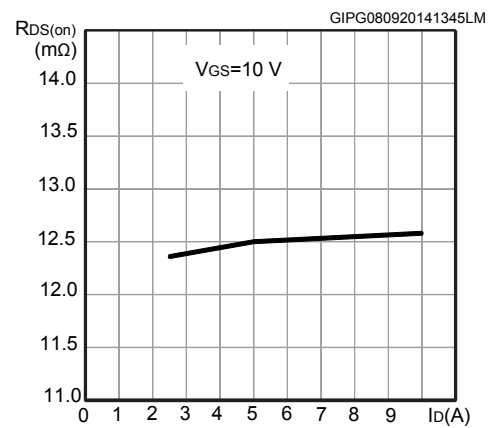
**Figure 4. Transfer characteristics**



**Figure 5. Gate charge vs gate-source voltage**

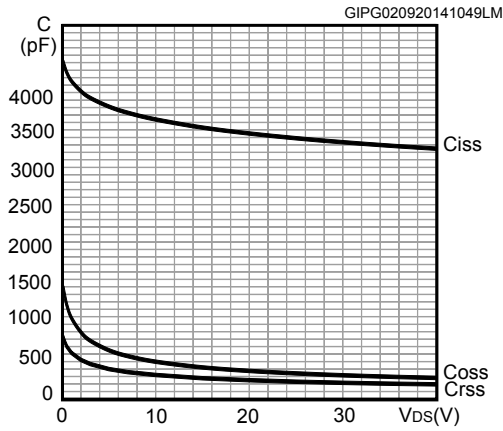


**Figure 6. Static drain-source on-resistance**

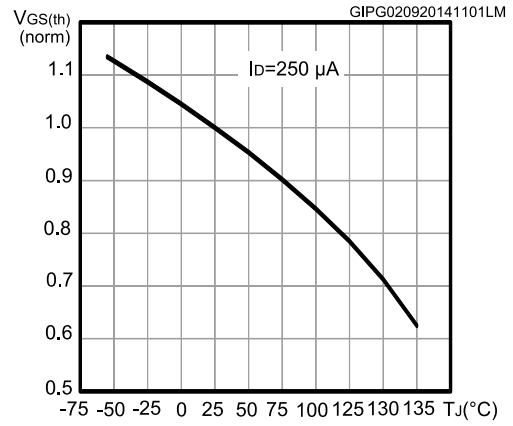


**Note:** For the P-channel Power MOSFET, current and voltage polarities are reversed.

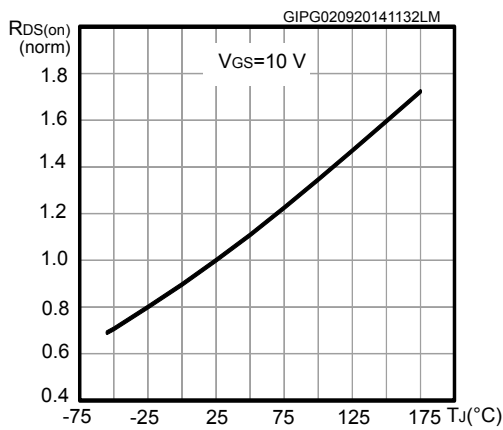
**Figure 7. Capacitance variation**



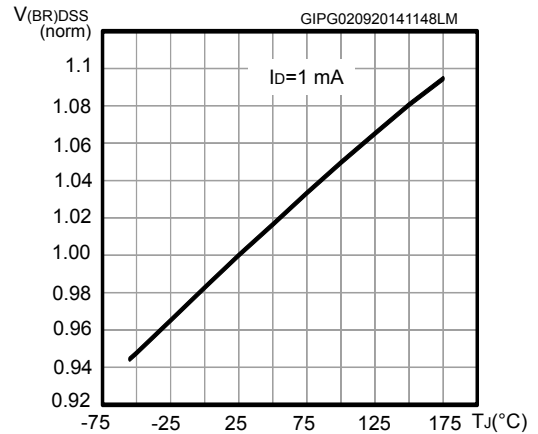
**Figure 8. Normalized gate threshold voltage vs temperature**



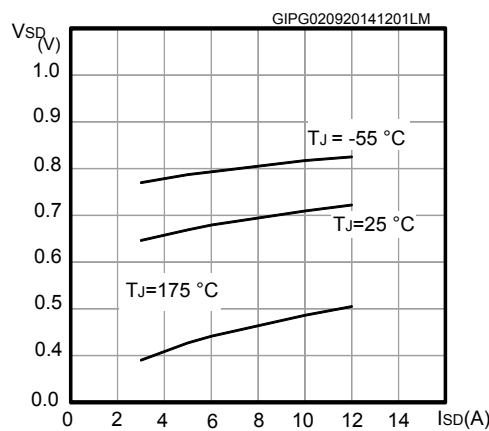
**Figure 9. Normalized on-resistance vs temperature**



**Figure 10. Normalized VBR(DSS) vs temperature**



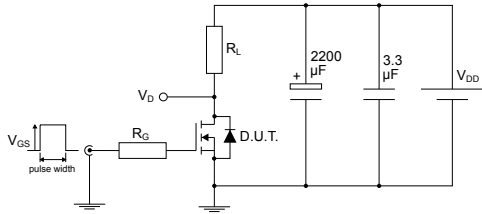
**Figure 11. Source-drain diode forward characteristics**



**Note:** For the P-channel Power MOSFET, current and voltage polarities are reversed.

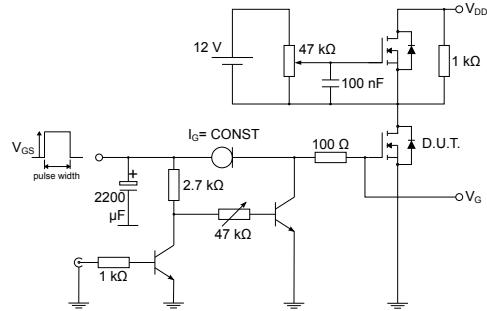
### 3 Test circuits

Figure 12. Test circuit for resistive load switching times



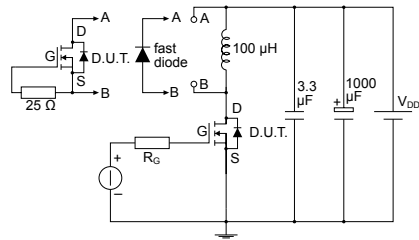
AM01468v1

Figure 13. Test circuit for gate charge behavior



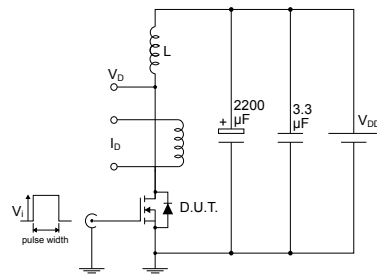
AM01469v1

Figure 14. Test circuit for inductive load switching and diode recovery times



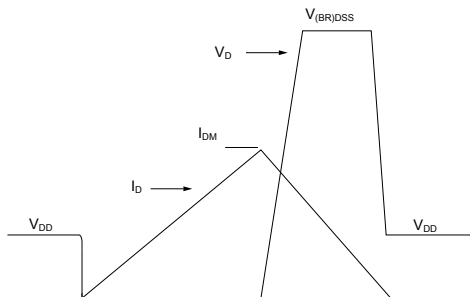
AM01470v1

Figure 15. Unclamped inductive load test circuit



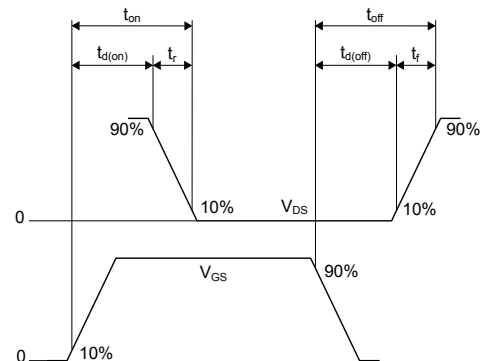
AM01471v1

Figure 16. Unclamped inductive waveform



AM01472v1

Figure 17. Switching time waveform



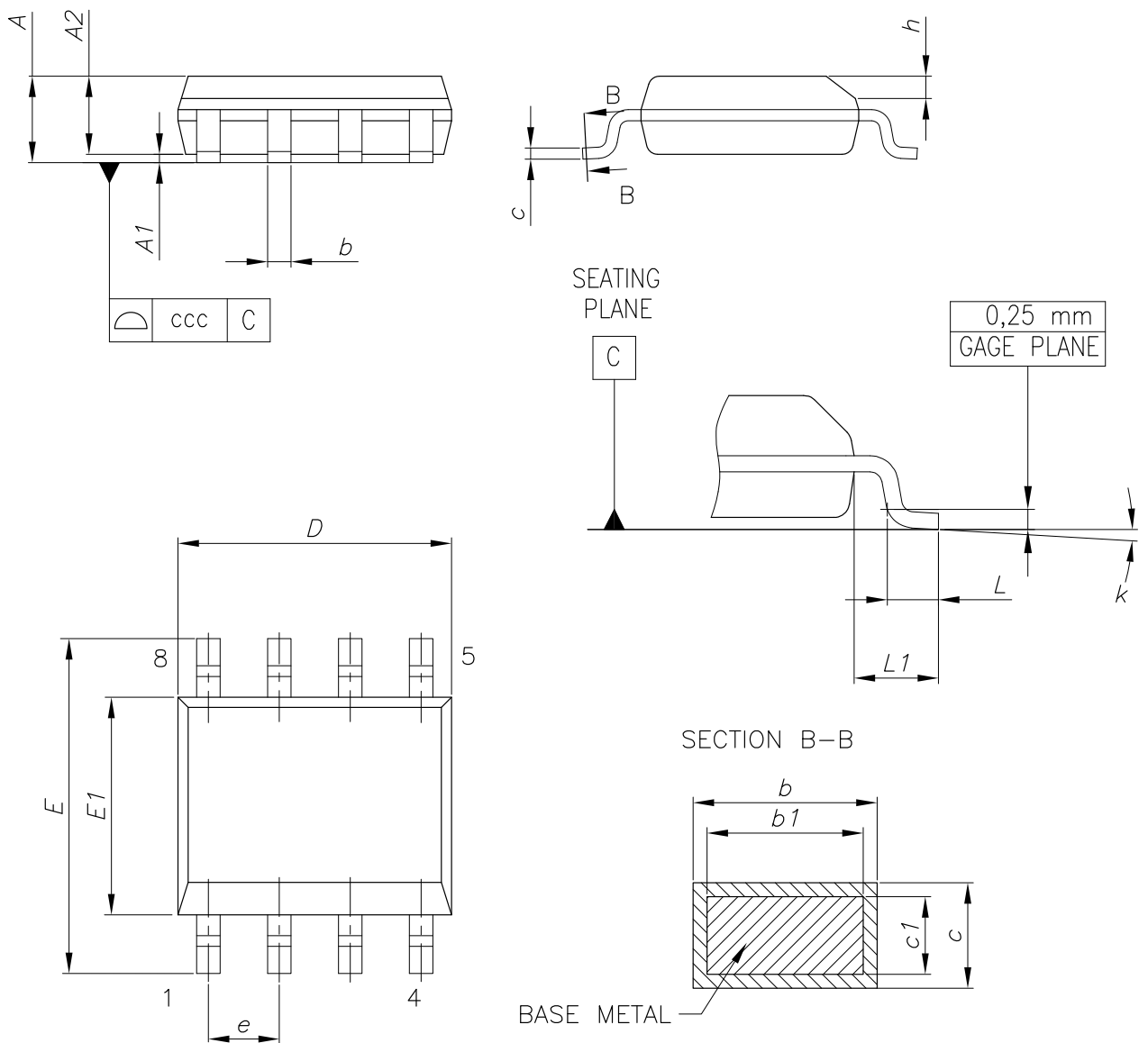
AM01473v1

## 4 Package information

In order to meet environmental requirements, ST offers these devices in different grades of **ECOPACK** packages, depending on their level of environmental compliance. ECOPACK specifications, grade definitions and product status are available at: [www.st.com](http://www.st.com). ECOPACK is an ST trademark.

### 4.1 SO-8 package information

Figure 18. SO-8 package outline

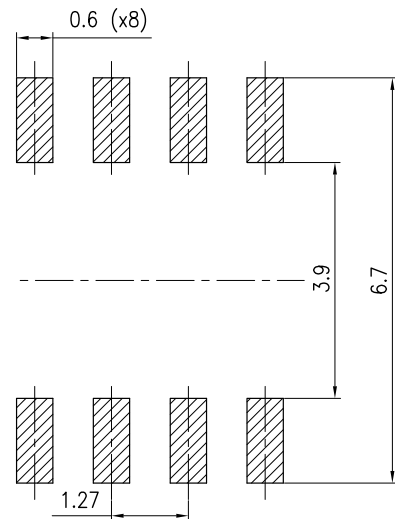


0016023\_So-807\_fig2\_Rev10

**Table 7. SO-8 mechanical data**

Dim.	mm		
	Min.	Typ.	Max.
A			1.75
A1	0.10		0.25
A2	1.25		
b	0.31		0.51
b1	0.28		0.48
c	0.10		0.25
c1	0.10		0.23
D	4.80	4.90	5.00
E	5.80	6.00	6.20
E1	3.80	3.90	4.00
e		1.27	
h	0.25		0.50
L	0.40		1.27
L1		1.04	
L2		0.25	
k	0°		8°
ccc			0.10

**Figure 19. SO-8 recommended footprint (dimensions are in mm)**



0016023\_So-807\_footprint\_Rev10



## 4.2 SO-8 packing information

Figure 20. SO-8 tape and reel dimensions

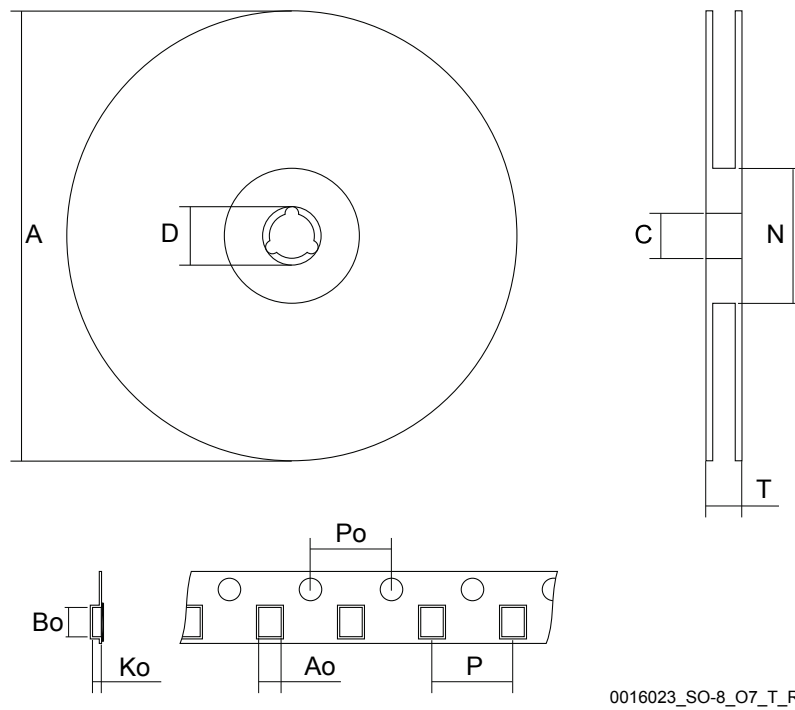
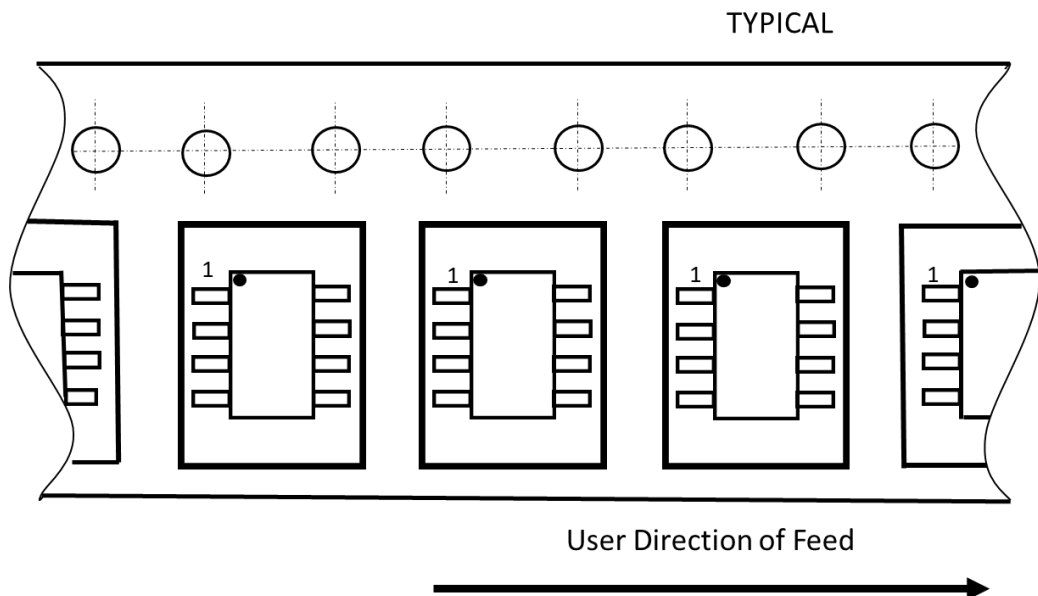


Figure 21. Tape orientation



**Table 8. SO-8 tape and reel mechanical data**

Dim.	mm		
	Min.	Typ.	Max.
A			330
C	12.8		13.2
D	20.2		
N	60		
T			22.4
Ao	6.5	-	6.7
Bo	5.4		5.6
Ko	2.0		2.2
Po	3.9		4.1
P	7.9		8.1

## Revision history

**Table 9. Document revision history**

Date	Revision	Changes
20-Jan-2014	1	First revision.
09-Sep-2014	2	Changed the title. Updated <i>Section "Features" and Section "Description"</i> . Updated <i>Table 4: "On/off states", Table 5: "Dynamic", Table 6: "Switching times", Table 7: "Source-drain diode"</i> . Added <i>Section 3: "Electrical characteristics (curves)"</i> .
16-Dec-2014	3	Document status promoted from preliminary data to production data. Minor text changes.
09-Dec-2020	4	Updated title and features in cover page. Updated <i>Section 1 Electrical ratings and Section 2 Electrical characteristics</i> . Minor text changes.
21-Jan-2021	5	Updated <a href="#">Internal schematic</a> . Minor text changes.

---

## Contents

<b>1</b>	<b>Electrical ratings</b> .....	<b>2</b>
<b>2</b>	<b>Electrical characteristics</b> .....	<b>3</b>
<b>2.1</b>	Electrical characteristics (curves) .....	<b>4</b>
<b>3</b>	<b>Test circuits</b> .....	<b>6</b>
<b>4</b>	<b>Package information</b> .....	<b>7</b>
<b>4.1</b>	SO-8 package information .....	<b>7</b>
<b>4.2</b>	SO-8 packing information .....	<b>9</b>
	<b>Revision history</b> .....	<b>11</b>

**IMPORTANT NOTICE – PLEASE READ CAREFULLY**

STMicroelectronics NV and its subsidiaries (“ST”) reserve the right to make changes, corrections, enhancements, modifications, and improvements to ST products and/or to this document at any time without notice. Purchasers should obtain the latest relevant information on ST products before placing orders. ST products are sold pursuant to ST’s terms and conditions of sale in place at the time of order acknowledgement.

Purchasers are solely responsible for the choice, selection, and use of ST products and ST assumes no liability for application assistance or the design of Purchasers’ products.

No license, express or implied, to any intellectual property right is granted by ST herein.

Resale of ST products with provisions different from the information set forth herein shall void any warranty granted by ST for such product.

ST and the ST logo are trademarks of ST. For additional information about ST trademarks, please refer to [www.st.com/trademarks](http://www.st.com/trademarks). All other product or service names are the property of their respective owners.

Information in this document supersedes and replaces information previously supplied in any prior versions of this document.

© 2021 STMicroelectronics – All rights reserved